

Serial EEPROM Series Automotive EEPROM
125°C Operation Microwire BUS EEPROM (3-wire)

BR93H66-2C

General Description

BR93H66-2C is a serial EEPROM of serial 3-line interface method.

Features

- Conforming to Microwire BUS
- Withstands Electrostatic Voltage up to 6kV (HBM method typ)
- Wide Temperature Range -40°C to +125°C
- Same package line-up and same pin configuration
- 2.5V to 5.5V Single Supply Voltage Operation
- Address Auto Increment Function at READ Operation
- Prevention of write mistake
 - Write prohibition at power on
 - Write prohibition by command code
 - Write mistake prevention circuit at low voltage
- Self-timed programming cycle
- Program Condition Display by READY / $\overline{\text{BUSY}}$
- Low Supply Current
 - Write Operation (5V) : 0.8mA (Typ)
 - Read Operation (5V) : 0.5mA (Typ)
 - Standby Operation (5V) : 0.1μA (Typ)
- Compact package MSOP8 / TSSOP-B8 / SOP8 / SOP-J8
- High-Reliability using ROHM Original Double-Cell Structure

- More than 50 years data retention ($T_a \leq 125^\circ\text{C}$)
- More than 300,000 write cycles ($T_a \leq 125^\circ\text{C}$)
- Data set to FFFFh on all addresses at shipment
- AEC-Q100 Qualified

Packages

- MSOP8
- TSSOP-B8
- SOP8
- SOP-J8

(Typ)	(Typ)	(Max)
2.90mm x 4.00mm x 0.90mm		
3.00mm x 6.40mm x 1.20mm		
5.00mm x 6.20mm x 1.71mm		
4.90mm x 6.00mm x 1.65mm		

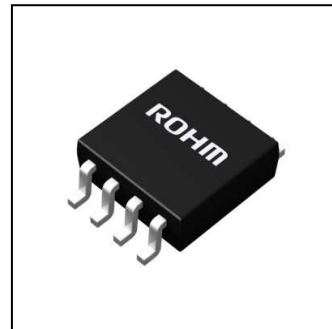

MSOP8

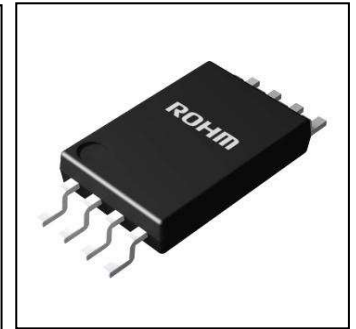

TSSOP-B8

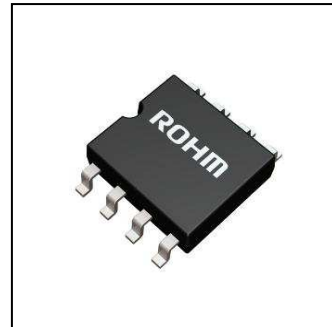

SOP8

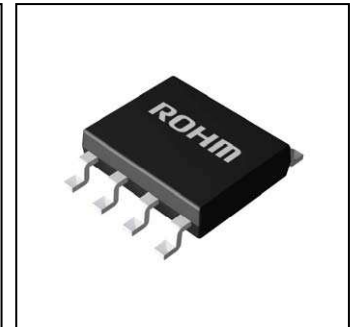

SOP-J8

BR93H66-2C

Package Type				MSOP8	TSSOP-B8	SOP8	SOP-J8
Capacity	Bit Format	Product Name	Supply Voltage	RFVM	RFVT	RF	RFJ
4Kbit	256 × 16	BR93H66-2C	2.5V to 5.5V	●	●	●	●

○Product structure : Silicon monolithic integrated circuit ○This product is not designed protection against radioactive rays

Absolute Maximum Ratings (Ta=25°C)

Parameter	Symbol	Limits	Unit
Supply Voltage	V _{CC}	-0.3 to +6.5	V
Permissible Dissipation	Pd	380 (MSOP8) ⁽¹⁾	mW
		410 (TSSOP-B8) ⁽²⁾	
		560 (SOP8) ⁽³⁾	
		560 (SOP-J8) ⁽⁴⁾	
Storage Temperature Range	T _{stg}	-65 to +150	°C
Operating Temperature Range	T _{opr}	-40 to +125	°C
Input Voltage/Output Voltage	-	-0.3 to V _{CC} +0.3	V

(1)When using at Ta=25°C or higher, 3.1mW(*1), 3.3mW(2), 4.5mW(3,4), to be reduced per 1°C.

Memory Cell Characteristics (V_{CC}=2.5V to 5.5V)

Parameter	Limits			Unit	Conditions
	Min	Typ	Max		
Write Cycles ⁽⁵⁾	1,000,000	-	-	Cycles	Ta ≤ 85°C
	500,000	-	-	Cycles	Ta ≤ 105°C
	300,000	-	-	Cycles	Ta ≤ 125°C
Data Retention ⁽⁵⁾	100	-	-	Years	Ta ≤ 25°C
	60	-	-	Years	Ta ≤ 105°C
	50	-	-	Years	Ta ≤ 125°C

(5) Not 100% TESTED

Recommended Action Conditions

Parameter	Symbol	Limits	Unit
Supply Voltage	V _{CC}	2.5 to 5.5	V
Input Voltage	V _{IN}	0 to V _{CC}	

DC Characteristics (Unless otherwise specified, Ta=-40°C to +125°C, V_{CC}=2.5V to 5.5V)

Parameter	Symbol	Limits			Unit	Conditions
		Min.	Typ.	Max.		
Input Low Voltage	V _{IL}	-0.3	-	0.3xV _{CC}	V	
Input High Voltage	V _{IH}	0.7xV _{CC}	-	V _{CC} +0.3	V	
Output Low Voltage 1	V _{OL1}	0	-	0.4	V	I _{OL} =2.1mA, 4.0V ≤ V _{CC} ≤ 5.5V
Output Low Voltage 2	V _{OL2}	0	-	0.2	V	I _{OL} =100μA
Output High Voltage 1	V _{OH1}	2.4	-	V _{CC}	V	I _{OH} =-0.4mA, 4.0V ≤ V _{CC} ≤ 5.5V
Output High Voltage 2	V _{OH2}	V _{CC} -0.2	-	V _{CC}	V	I _{OH} =-100μA
Input Leak Current	I _{LI}	-10	-	10	μA	V _{IN} =0V to V _{CC}
Output Leak Current	I _{LO}	-10	-	10	μA	V _{OUT} =0V to V _{CC} , CS=0V
Supply Current	I _{CC1}	-	-	3.0	mA	f _{SK} =2MHz, t _{EW} =4ms (WRITE)
	I _{CC2}	-	-	1.5	mA	f _{SK} =2MHz (READ)
	I _{CC3}	-	-	3.0	mA	f _{SK} =2MHz, t _{EW} =4ms (WRAL)
Standby Current	I _{SB}	-	-	10	μA	CS=0V, DO=OPEN

©Radiation resistance design is not made.

AC Characteristics (Unless otherwise specified, Ta=-40°C to +125°C, V_{CC}=2.5V to 5.5V)

Parameter	Symbol	Min.	Typ.	Max.	Unit
SK Frequency	f _{SK}	-	-	2	MHz
SK "H" Time	t _{SKH}	200	-	-	ns
SK "L" Time	t _{SKL}	200	-	-	ns
CS "L" Time	t _{CS}	200	-	-	ns
CS Setup Time	t _{CSS}	50	-	-	ns
DI Setup Time	t _{DIS}	50	-	-	ns
CS Hold Time	t _{CSH}	0	-	-	ns
DI Hold Time	t _{DIH}	50	-	-	ns
Data "1" Output Delay Time	t _{PD1}	-	-	200	ns
Data "0" Output Delay Time	t _{PD0}	-	-	200	ns
Time from CS to Output establishment	t _{SV}	-	-	150	ns
Time from CS to High-Z	t _{DF}	-	-	150	ns
Write Cycle Time	t _{EW}	-	-	4	ms

Serial Input / Output Timing

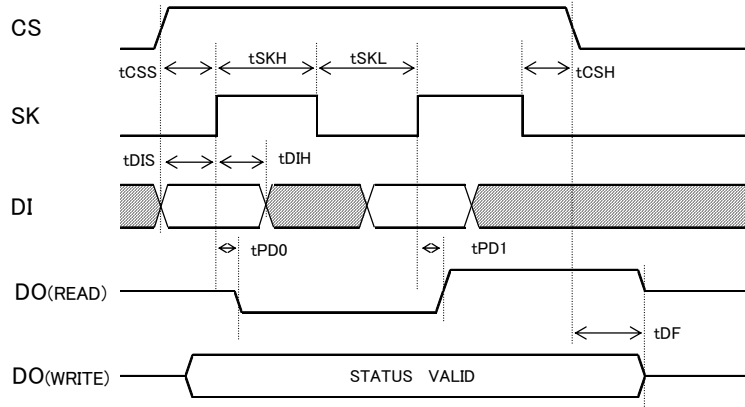

Figure 1. Serial Input / Output Timing Diagram

1. Data is taken from DI, in sync with the rise of SK.
2. At READ command, data is outputted from DO in sync with the rise of SK.
3. After WRITE command input, the status signal of WRITE (READY / $\overline{\text{BUSY}}$) can be monitored from DO by setting CS to "H" after t_{CS} , from the fall of CS, and will display a valid status until the next command start bit is inputted. But, if CS is set to "L", DO sets to High-Z state.
4. To execute a series of commands, CS is set to "L" once after completion of each command for internal circuit reset.

Block Diagram

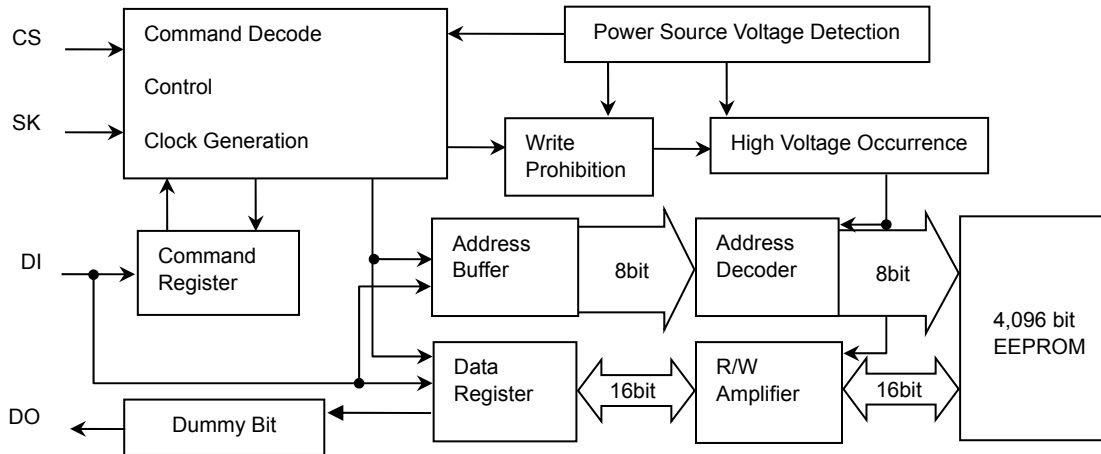

Figure 2. Block Diagram

Pin Configuration

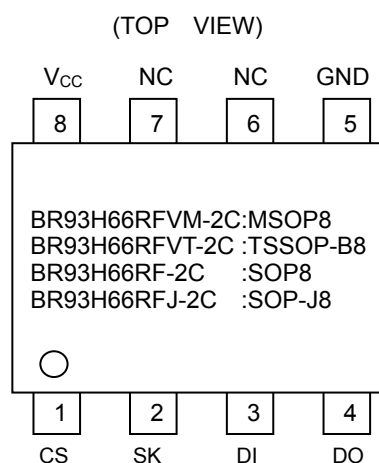

Figure 3. Pin Configuration

Pin Descriptions

Pin Number	Pin Name	I / O	Function
1	CS	Input	Chip select input
2	SK	Input	Serial clock input
3	DI	Input	Start bit, ope code, address, and serial data input
4	DO	Output	Serial data output, READY / $\overline{\text{BUSY}}$ status output
5	GND	-	Ground, 0V
6,7	NC	-	Non connected terminal, V _{CC} , GND or OPEN
8	VCC	-	Power supply, 2.5V to 5.5V

Typical Performance Curves

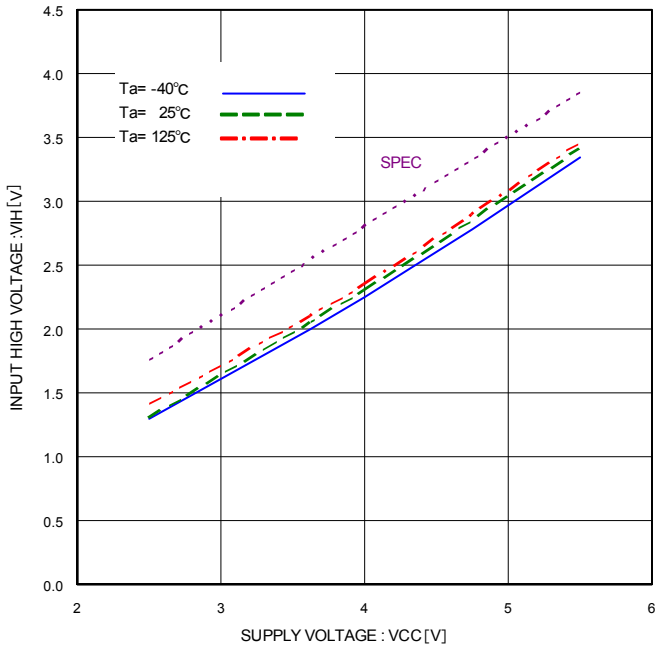

Figure 4. Input High Voltage (CS,SK,DI) vs. Supply Voltage

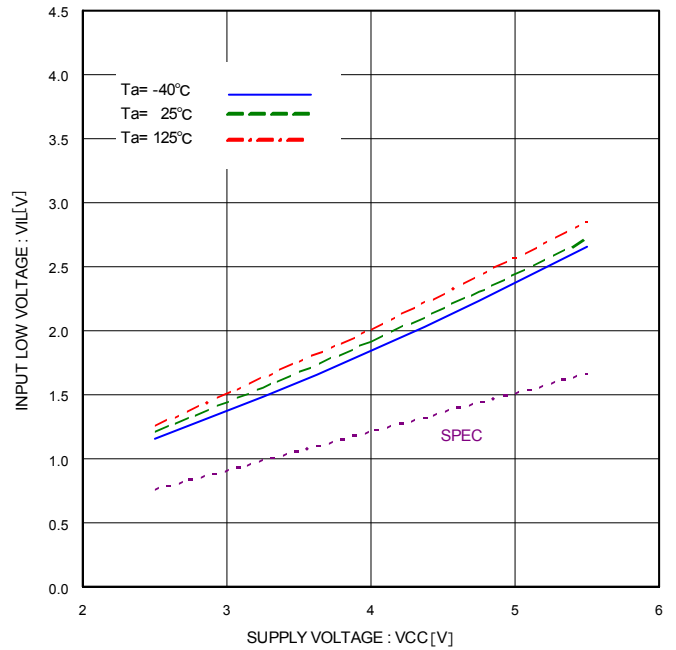

Figure 5. Input Low Voltage (CS,SK,DI) vs. Supply Voltage

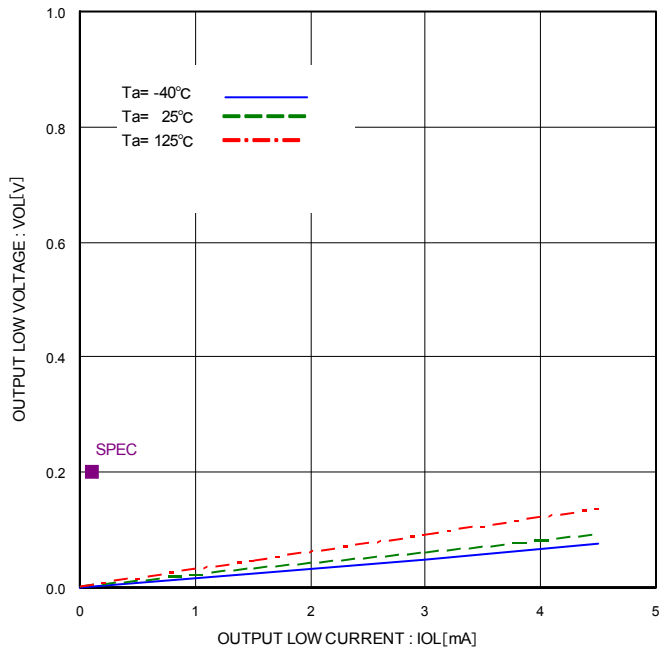

Figure 6. Output Low Voltage vs. Output Low Current (V_{CC}=2.5V)

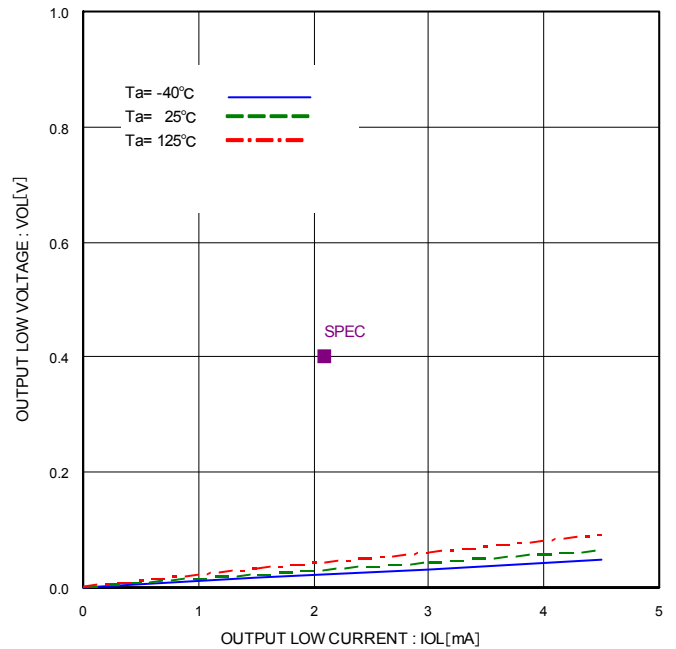

Figure 7. Output Low Voltage vs. Output Low Current (V_{CC}=4.0V)

Typical Performance Curves - Continued

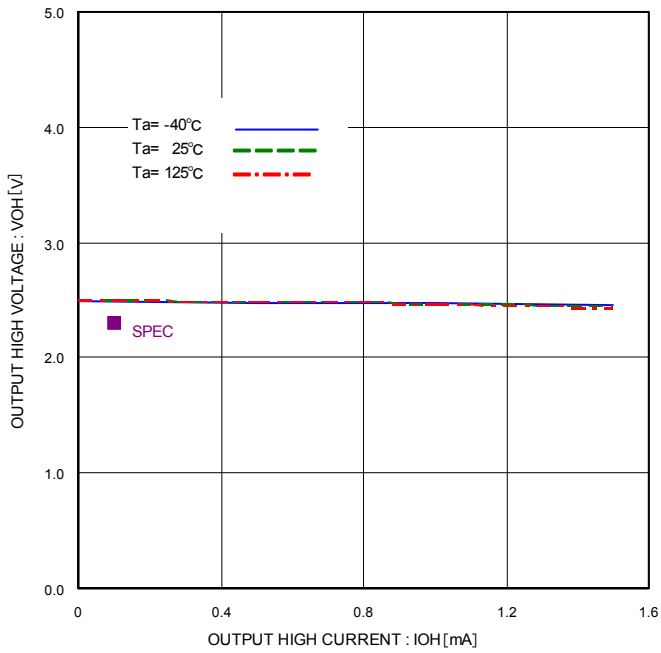

Figure 8. Output High Voltage vs. Output High Current (V_{CC}=2.5V)

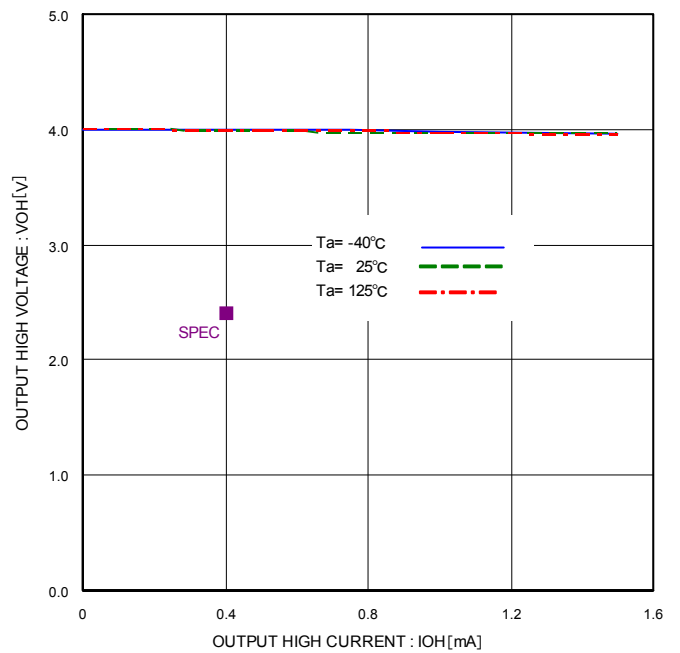

Figure 9. Output High Voltage vs. Output High Current (V_{CC}=4.0V)

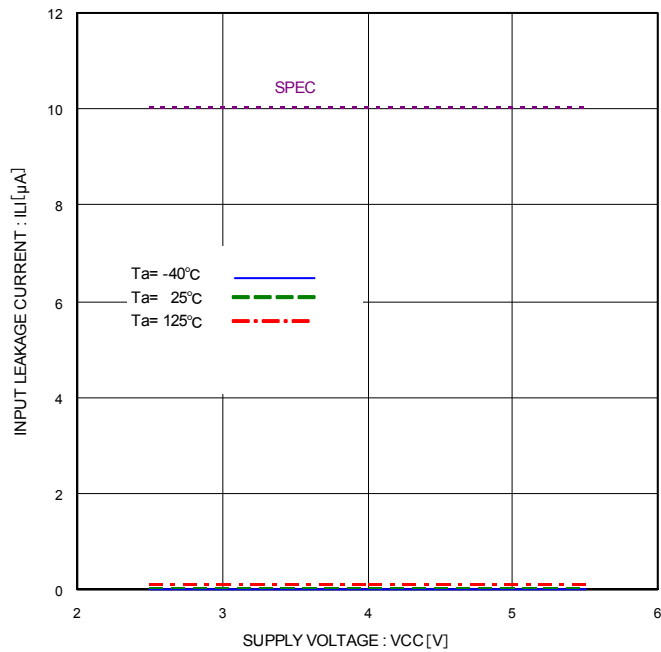

Figure 10. Input Leak Current (CS,SK,DI) vs. Supply Voltage

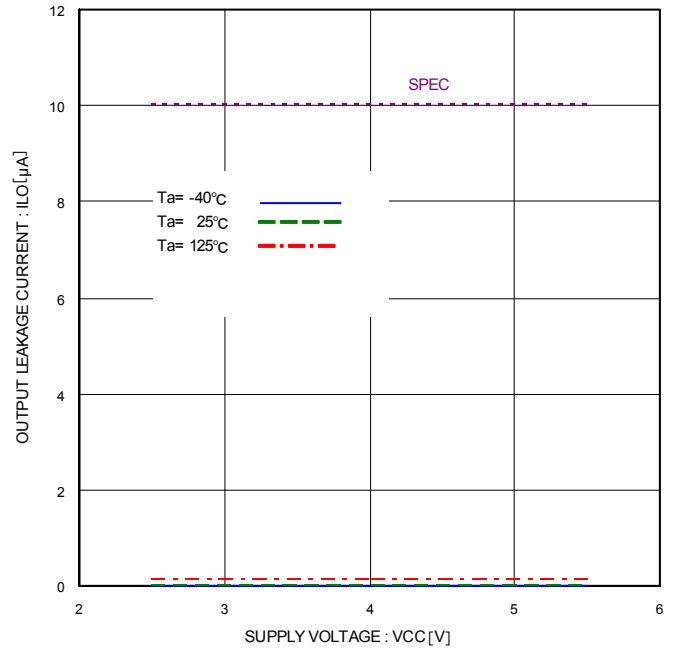

Figure 11. Output Leak Current (DO) vs. Supply Voltage

Typical Performance Curves - Continued

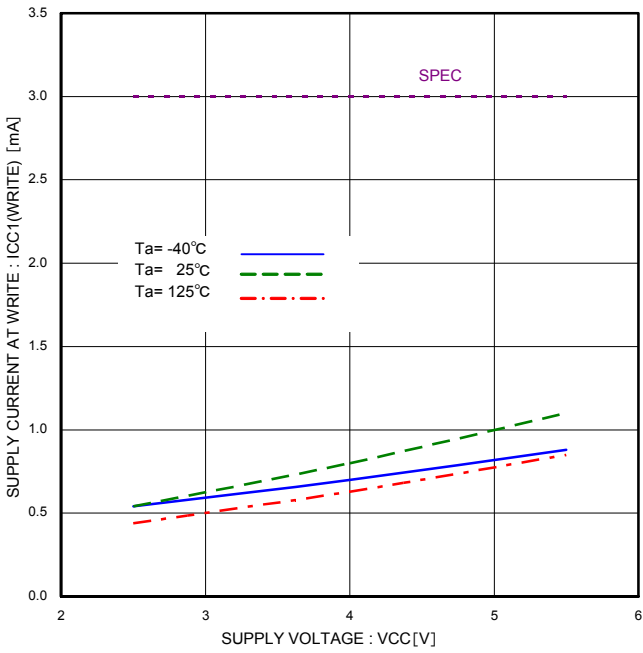

Figure 12. Supply Current at WRITE Operation vs. Supply Voltage (WRITE, $f_{SK}=2.0\text{MHz}$)

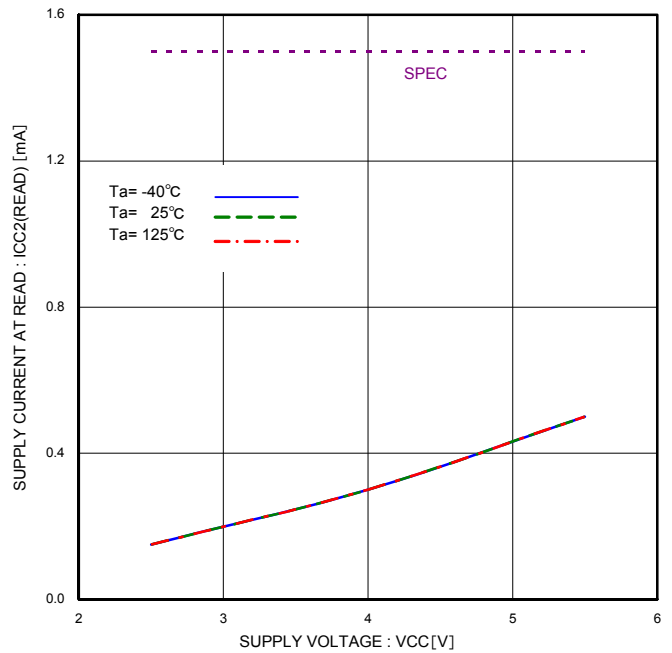

Figure 13. Supply Current at READ Operation vs. Supply Voltage (READ, $f_{SK}=2.0\text{MHz}$)

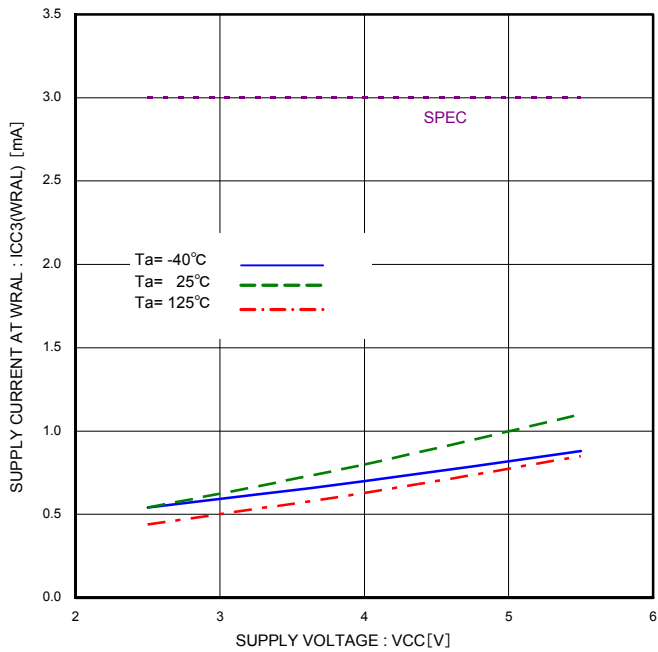

Figure 14. Supply Current at WRAL Operation vs. Supply Voltage (WRAL, $f_{SK}=2.0\text{MHz}$)

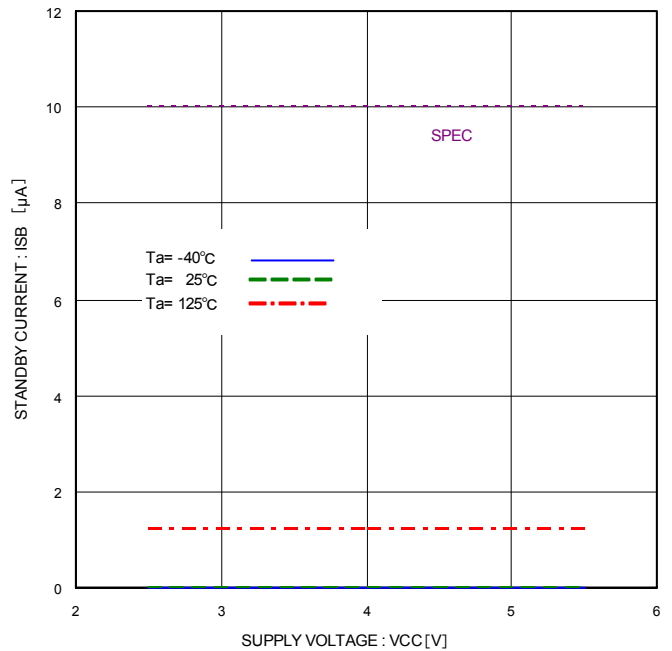

Figure 15. Standby Current vs. Supply Voltage

Typical Performance Curves - Continued

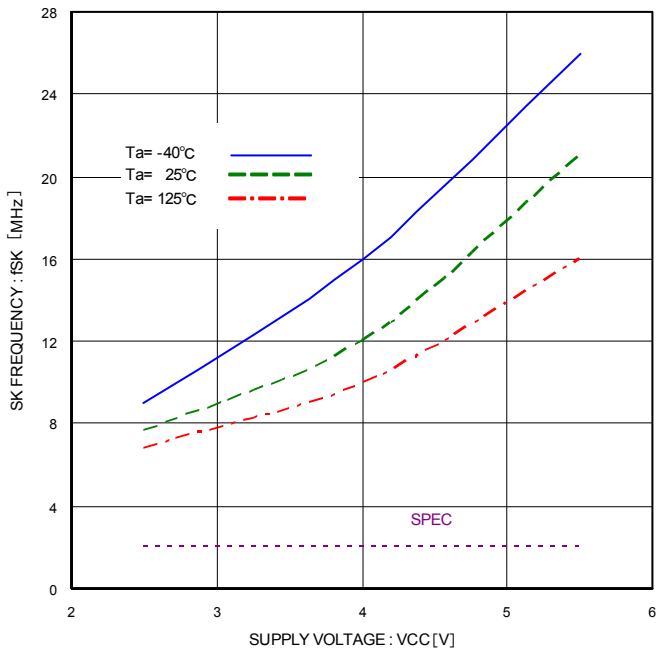

Figure 16. SK Frequency vs. Supply Voltage

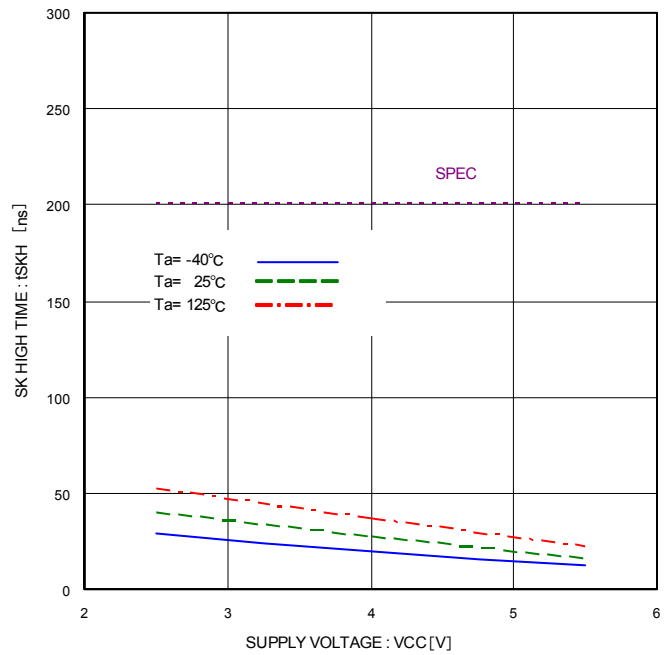

Figure 17. SK High Time vs. Supply Voltage

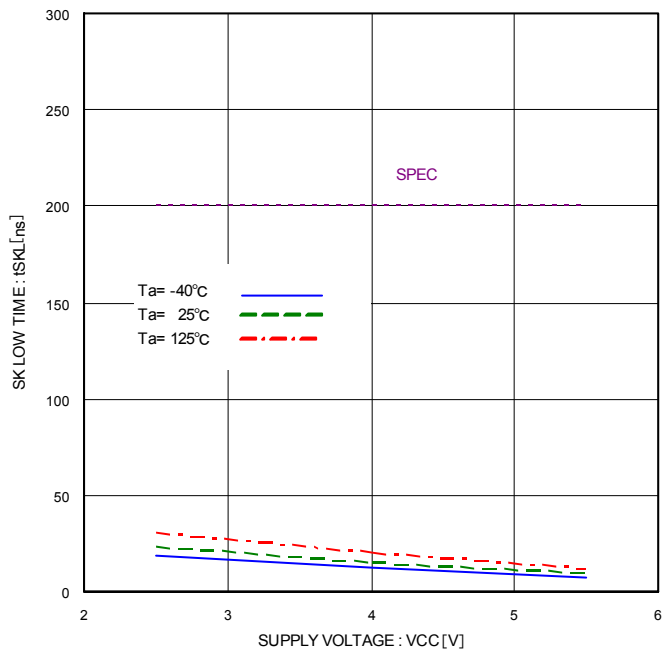

Figure 18. SK Low Time vs. Supply Voltage

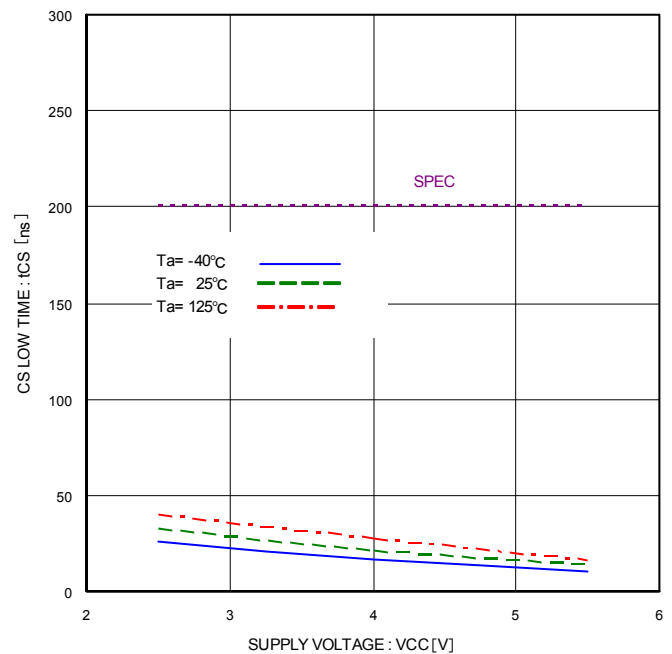

Figure 19. CS Low Time vs. Supply Voltage

Typical Performance Curves - Continued

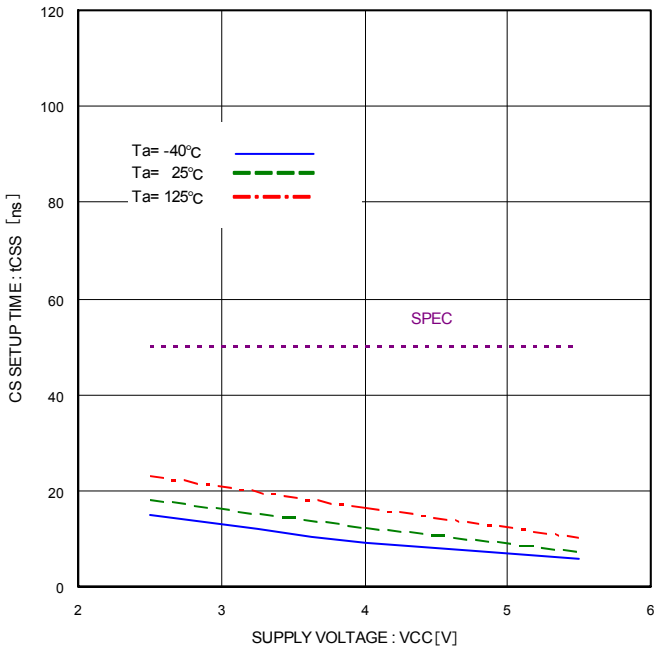

Figure 20. CS Setup Time vs. Supply Voltage

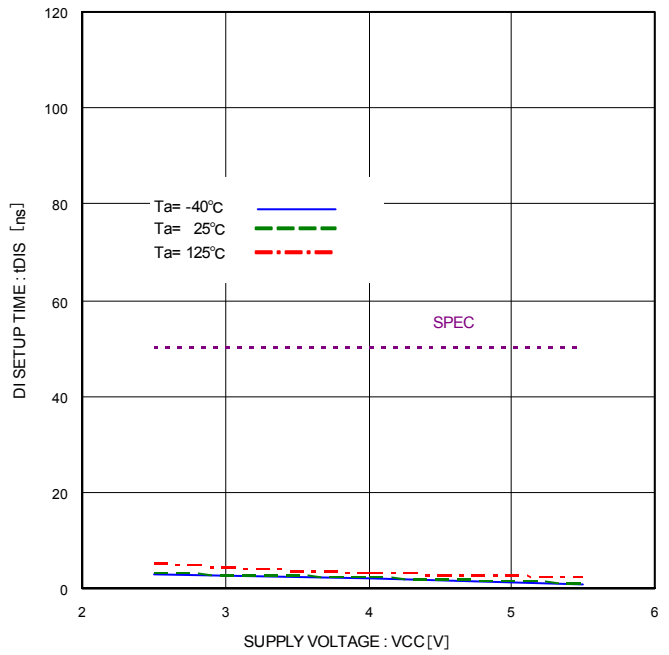

Figure 21. DI Setup Time vs. Supply Voltage

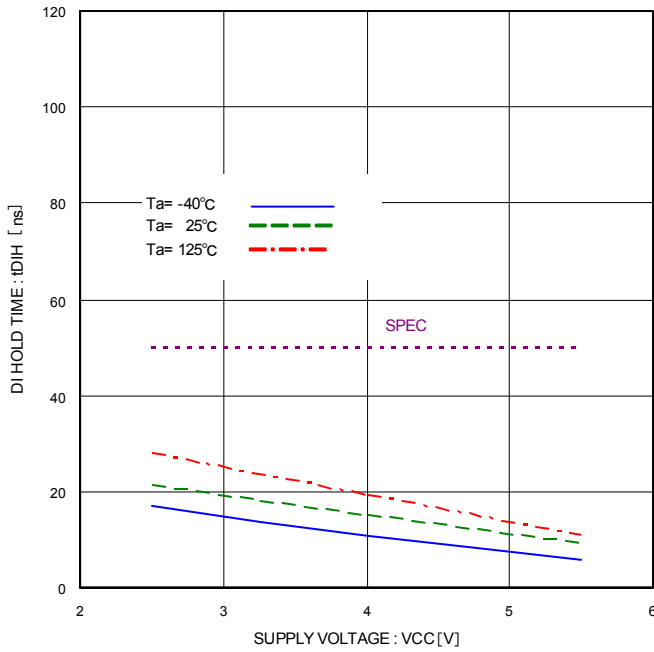

Figure 22. DI Hold Time vs. Supply Voltage

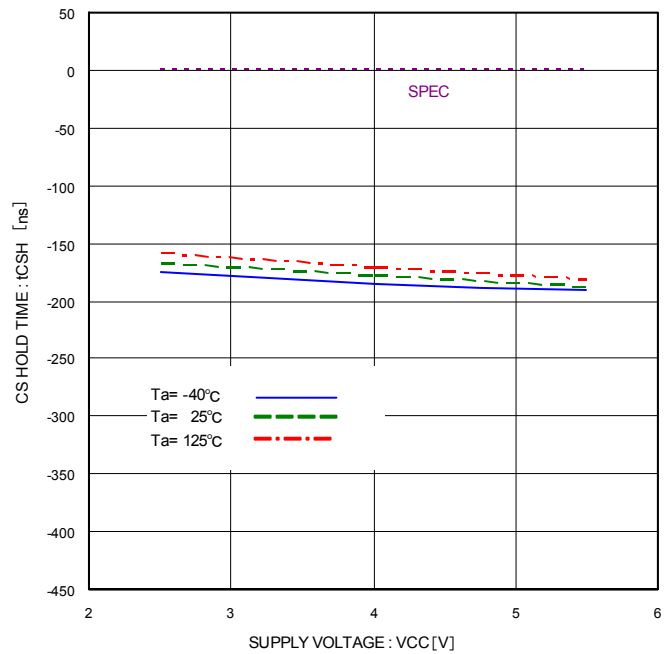

Figure 23. CS Hold Time vs. Supply Voltage

Typical Performance Curves - Continued

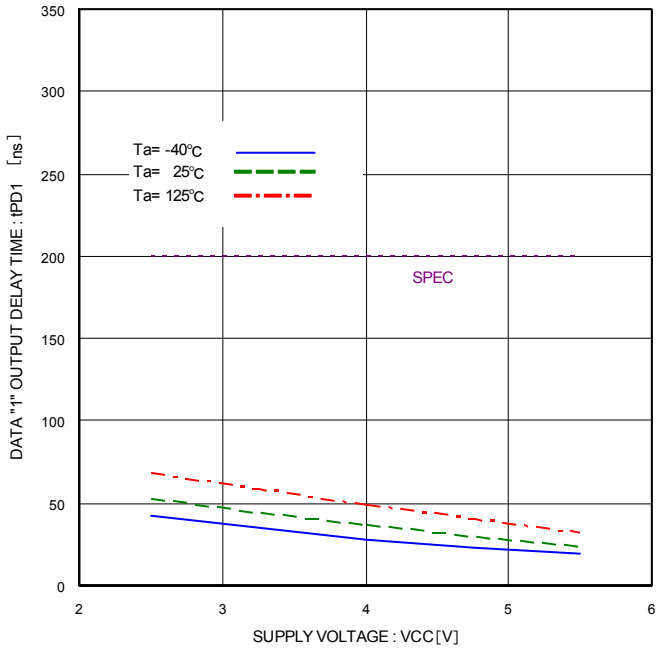

Figure 24. Data "1" Output Delay Time vs. Supply Voltage

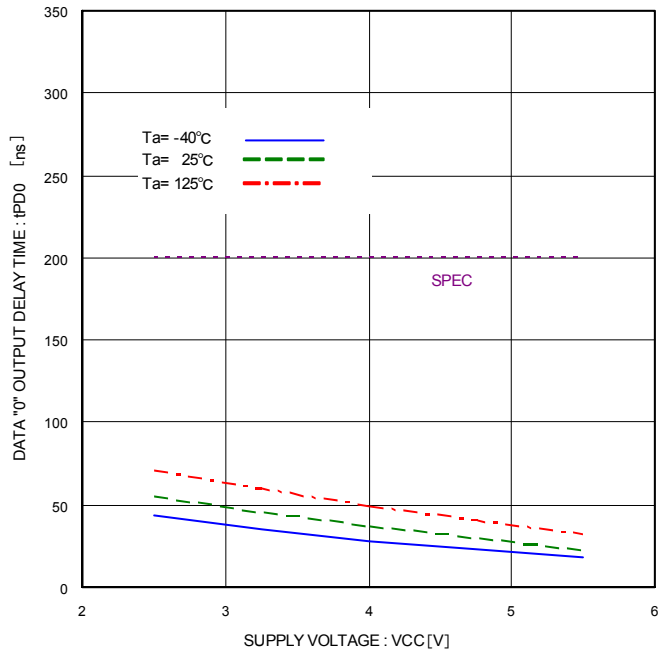

Figure 25. Data "0" Output Delay Time vs. Supply Voltage

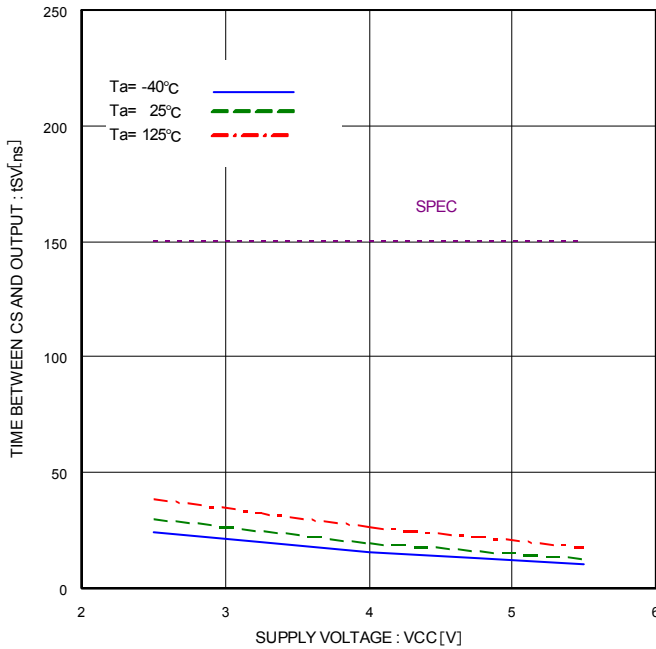

Figure 26. Time from CS Output establishment vs. Supply Voltage

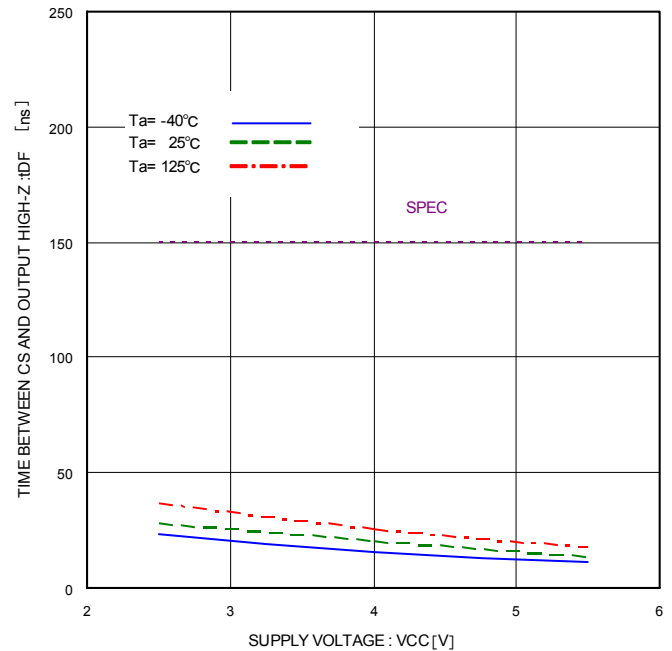

Figure 27. Time from CS to High-Z vs. Supply Voltage

Typical Performance Curves - Continued

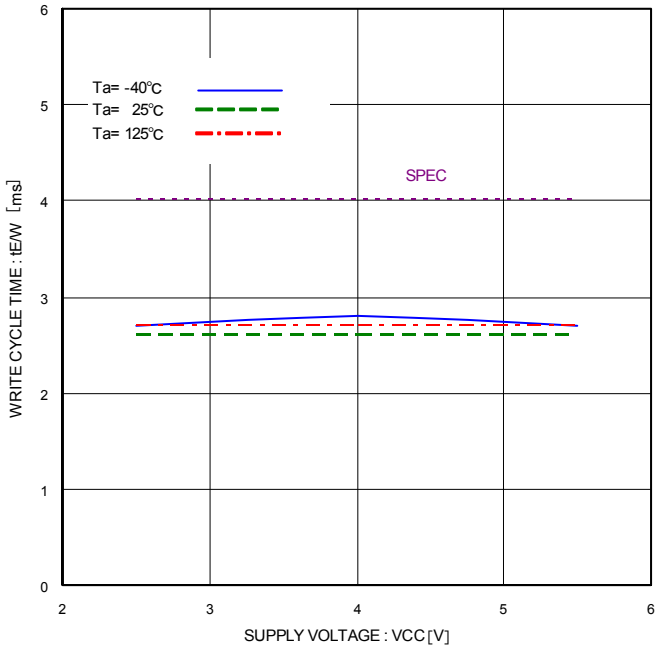

Figure 28. Write Cycle Time vs. Supply Voltage

Description of Operation

Communications of the Microwire Bus are carried out by SK (serial clock), DI (serial data input),DO (serial data output) ,and CS (chip select) for device selection.

In connecting one EEPROM to a microcontroller, connect it as shown in Figure.29-(a) or Figure.29-(b). And, when using the input and output common I/O port of the microcontroller, connect DI and DO via a resistor as shown in Figure.29-(b) (Refer to pages 19/29), wherein connection by 3 lines is possible.

In case of using multiple EEPROM devices, refer to Figure. 29-(c).

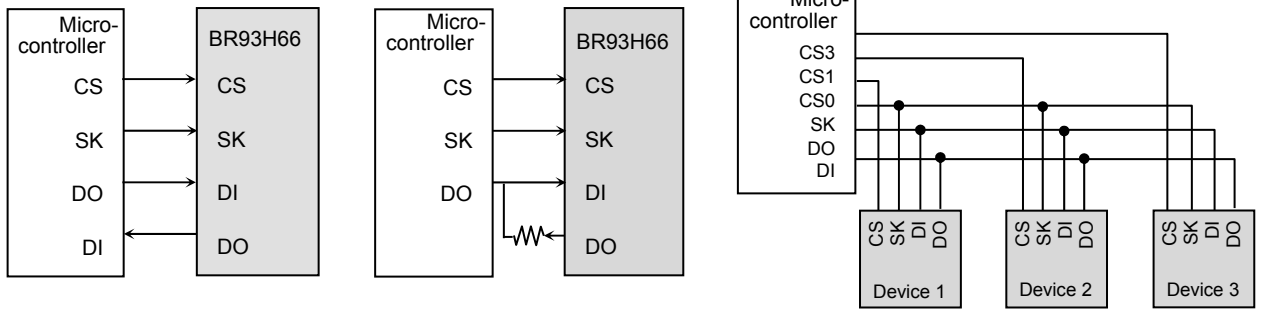

Figure 29-(a). Connection by 4 lines Figure 29-(b). Connection by 3 lines Figure 29-(c). Connection example of multiple devices

Figure 29. Connection Methods with Microcontroller

Communications of the Microwire Bus are started by the first “1” input after the rise of CS. This input is called the “Start Bit”. After input of the start bit, the “Ope Code”, Address, and Data are then inputted consecutively. Address and Data are all inputted with MSB first.

All “0” signal inputs after the rise of CS up to the start bit is ignored. Therefore, if there is a limitation in the bit width of PIC of the microcontroller, it is possible to input “0” before the start bit to control the bit width.

Command Mode

Command	Start bit	Ope code	Address	Data
			BR93H66-2C	
Read (READ) ⁽¹⁾	1	10	A7,A6,A5,A4,A3,A2,A1,A0	D15 to D0(READ DATA)
Write enable (WEN)	1	00	1 1 * * * * * *	-
Write (WRITE) ⁽²⁾	1	01	A7,A6,A5,A4,A3,A2,A1,A0	D15 to D0(WRITE DATA)
Write all (WRAL) ^(2,3)	1	00	0 1 * * * * * B0	D15 to D0(WRITE DATA)
Write disable (WDS)	1	00	0 0 * * * * * *	-

- Input the address and the data in MSB-first order.
- As for *, input either V_H or V_{IL}.

*Start bit

Acceptance of all the commands of this IC starts at recognition of the start bit.
The “Start Bit” means the first “1” input after the rise of CS.

- (1) For READ, after setting the command, the data output of the selected address starts. Then, in a sequential order of addresses, the data of the next address will be outputted, and will continuously output data of succeeding addresses with the use of a continuous SK clock input. (Auto-Increment Function)
- (2) When the WRITE and the WRITE-All commands are executed, the previous data written in the selected memory cell are automatically deleted first, then the input data is written next.
- (3) For the WRITE-ALL command, data written in memory cell of the areas designated by B0 are automatically deleted, and input data is written in bulk.

Write All Area

B0	Write Area
0	000h to 07Fh
1	080h to 0FFh

• The write all command is written in bulk in 2Kbit unit. The write area can be selected up to 1bit. Confirm on the left side the settings and write areas of B0.

Timing Chart

1. Read Cycle (READ)

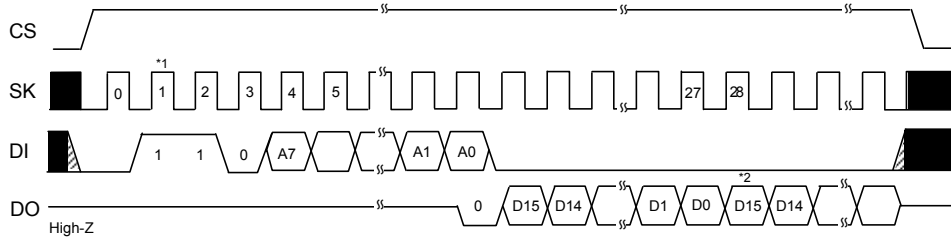

(1) Start bit

When data "1" is input for the first time after the rise of CS, this will be recognized as the start bit. And, even if multiple "0" are input after the rise of CS, the first "1" input will still be recognized as the start bit, and the following operation starts. This is common to all the commands that will be discussed hereafter.

(2) The succeeding address' data output

(Auto-Increment Function)

Figure 30. Read Cycle

(1) When the READ command is recognized, the data (16bit) of the selected address is output to serial. And at that moment, "0" (dummy bit) is output first, in sync with address bit A0 and with the rise of SK. After which, the main data is output in sync with the rise of SK.

This IC has Address Auto Increment Function available only for READ command, wherein after executing READ command on the first selected address, the data of the next address is read. And this will continue in a sequential order of addresses with the use of a continuous SK clock input, and by keeping CS at "H" during auto-increment.

2. Write Cycle (WRITE)

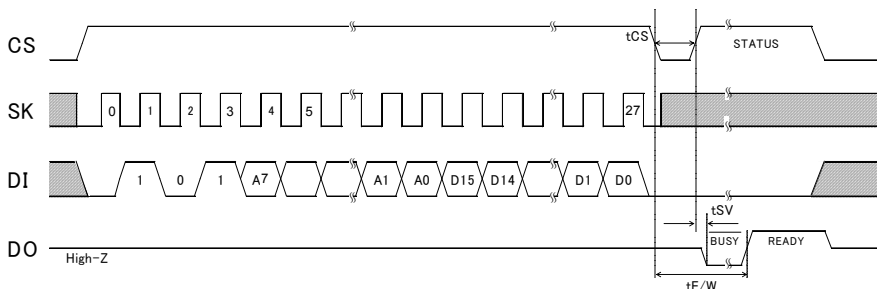

Figure 31. Write Cycle

(1) In this command, input 16-bit data (D15 to D0) are written to a designated address (A7 to A0). The actual write starts from the fall of CS, after D0 is sampled with SK clock (27th clock from the start bit input), to the rise of the 28th clock. When STATUS is not detected (CS="L" fixed), WRITE time is 4ms (Max.) in conformity with tE/W. And when STATUS is detected (CS="H"), all commands are not accepted for areas where "L" (BUSY) is output from D0. Therefore, do not input any command.

Write is not made or canceled if CS starts to fall after the rise of the 28th clock.

Note) Take tSKH or more from the rise of the 27th clock to the fall of CS.

3. Write All Cycle (WRAL)

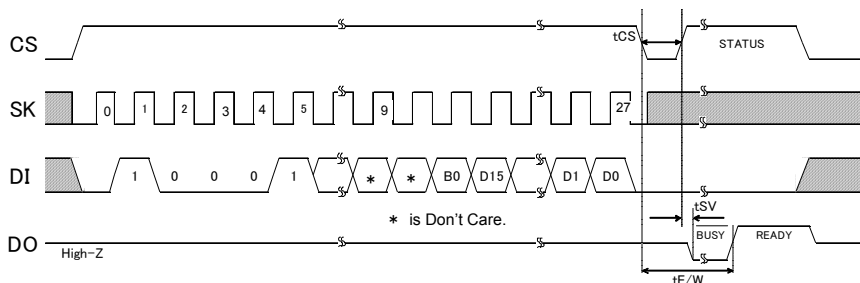

Figure 32. Write All Cycle

(1) In this command, input 16-bit data is written simultaneously to designated block for 128 words. Data is written in bulk at a write time of only 4ms (Max) in conformity with tE/W. When writing data to all addresses, designate each block by B0 and execute write. Write time is 4ms (Max).

The actual write starts from the fall of CS, after D0 is sampled with SK clock (27th clock from the start bit input), to the rise of the 28th clock. If CS was ended after the rise of the 28th clock, command is canceled, and write is not completed.

Note: Take tSKH or more from the rise of the 27th clock to the fall of CS.

4. Write Enable (WEN) / Disable (WDS) Cycle

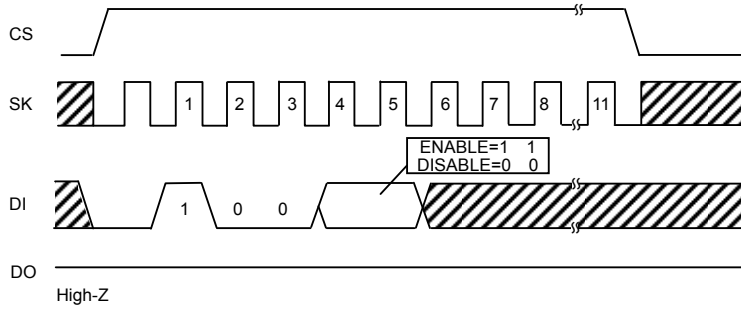

Figure 33. Write Enable (WEN) / Disable (WDS) Cycle

- (1) At power on, this IC is in Write Disable status by the internal RESET circuit. Before executing the WRITE command, it is necessary to execute the Write Enable command first. And, once this command is executed, writing is valid until the Write Disable command is executed or the power is turned off. However, the READ command is valid regardless of whether the Write Enable / Disable command is executed. Input to SK after 6 clocks of this command is available by either "H" or "L", but be sure to input it.
- (2) When the Write Enable command is executed after power on, Write Enable status gets in. When the Write Disable command is executed then, the IC gets in Write Disable status as same as at power on, and then the WRITE command is canceled thereafter in software manner. However, the READ command is still executable. In Write Enable status, even when the WRITE command is input by mistake, writing will still continue. To prevent such a mistake, it is recommended to execute the write disable command after the completion of each WRITE execution.

Application

1. Method to Cancel each Command

(1) READ

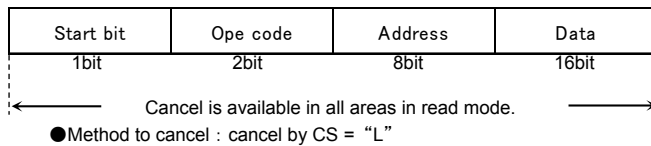
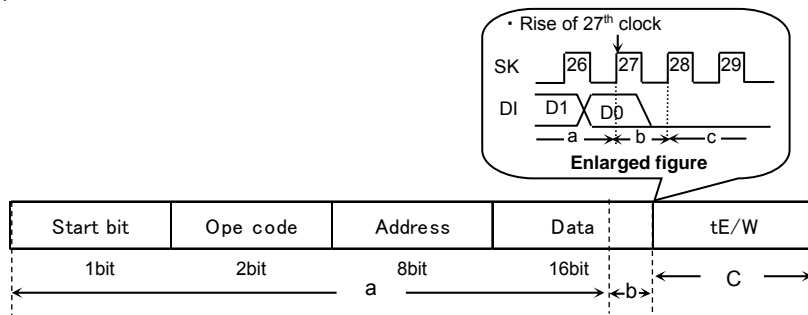

Figure 34. READ Cancel Available Timing

(2) WRITE, WRAL



- a : From start bit to 27th clock rise
Cancel by CS="L"
- b : 27th clock rise and after
Cancellation is not available by any means. If Vcc is turned OFF in this area, designated address data is not guaranteed, therefore write once again.
- c : 28th clock rise and after
Cancel by CS="L"
However, when write is started in b area (CS is ended), cancellation is not available by any means.
And when SK clock is input continuously, cancellation is not available.

Note 1) If Vcc is turned OFF in this area, designated address data is not guaranteed. Therefore, it is recommended to execute WRITE once again.

Note 2) If CS is started at the same timing as that of the SK rise, write execution/cancel becomes unstable. Therefore, it is recommended to set CS to "L" in SK="L" area. As for SK rise, recommended timing is of t_{CS}/t_{CSH} or higher.

Figure 35. WRITE, WRAL Cancel Available Timing

2. I/O Equivalent Circuit
 (1) Output Circuit

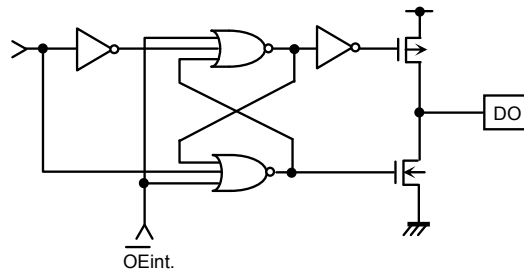

Figure 36. Output Circuit (DO)

(2) Input Circuit

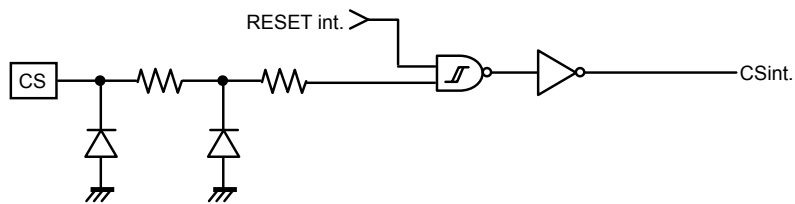

Figure 37. Input Circuit (CS)

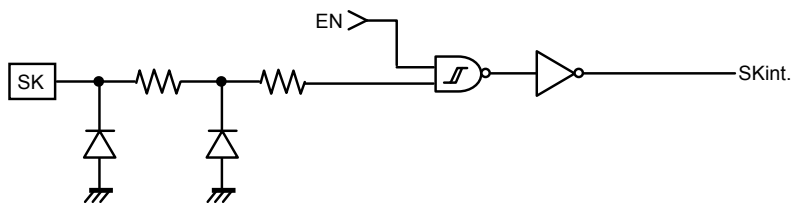

Figure 38. Input Circuit (SK)

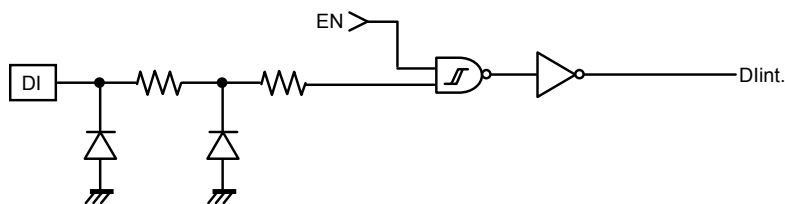

Figure 39. Input Circuit (DI)

3. I/O Peripheral Circuit

(1) Pull down CS

By making CS="L" at power ON/OFF, mistake in operation and mistake write are prevented.

(a) Pull down Resistance Rpd of CS pin

To prevent mistake in operation and mistake write at power ON/OFF, a CS pull down resistor is necessary. Select an appropriate resistance value from microcontroller's V_{OH} , I_{OH} and this IC's V_{IH} characteristics.

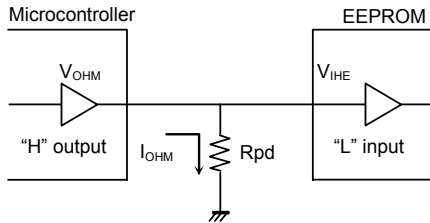

Figure 40. CS Pull down Resistance

$$R_{pd} \geq \frac{V_{OHM}}{I_{OHM}} \quad \dots \textcircled{1}$$

$$V_{OHM} \geq V_{IHE} \quad \dots \textcircled{2}$$

Example) When $V_{CC} = 5V$, $V_{IHE} = 3.5V$, $V_{OHM} = 4.0V$, $I_{OHM} = 2mA$, from the equation $\textcircled{1}$,

$$R_{pd} \geq \frac{4.0}{2 \times 10^{-3}}$$

$$\therefore R_{pd} \geq 2.0 [k\Omega]$$

With the value of R_{pd} satisfying the equation above, V_{OHM} becomes 4.0V or higher, and with $V_{IHE} (=3.5V)$, equation $\textcircled{2}$ is also satisfied.

- V_{IHE} : EEPROM V_{IH} specifications
- V_{OHM} : Microcontroller V_{OH} specifications
- I_{OHM} : Microcontroller I_{OH} specifications

(2) DO is available for both pull up and pull down.

DO output is "High-Z" except during READY / BUSY output timing in WRITE command and, after data output at READ command. When malfunction occurs at "High-Z" input of the microcontroller port connected to DO, it is necessary to pull down and pull up DO. When there is no influence upon the microcontroller actions, DO may be left OPEN. If DO is OPEN during a transition of output from BUSY to READY status, and at an instance where CS="H", SK="H", DI="H", EEPROM recognizes this as a start bit, resets READY output, and sets DO="High-Z". Therefore, READY signal cannot be detected. To avoid such output, pull up DO pin for improvement.

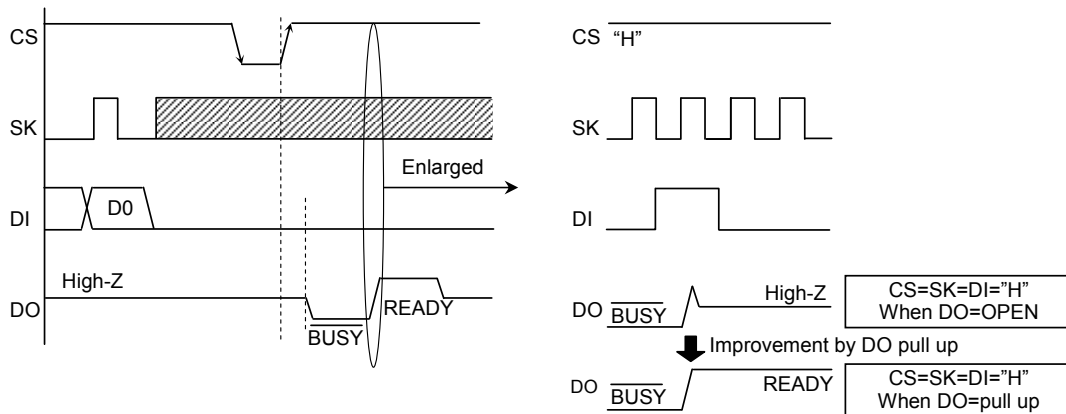

Figure 41. READY Output Timing at DO=OPEN

(a) Pull up Resistance Rpu and Pull down Resistance Rpd of DO pin

As for pull up and pull down resistance value, select an appropriate value to this resistance value from microcontroller VIH, VIL, and VOH, IOH, VOL, IOL characteristics of this IC.

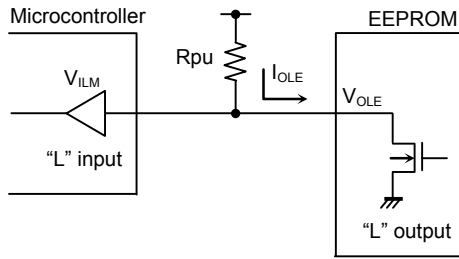

Figure 42. DO Pull up Resistance

$$R_{pu} \geq \frac{V_{CC} - V_{OLE}}{I_{OLE}} \quad \dots \textcircled{3}$$

$$V_{OLE} \leq V_{ILM} \quad \dots \textcircled{4}$$

Example) When $V_{CC} = 5V$, $V_{OLE} = 0.4V$, $I_{OLE} = 2.1mA$, $V_{ILM} = 0.8V$, from the equation $\textcircled{3}$,

$$R_{pu} \geq \frac{5 - 0.4}{2.1 \times 10^{-3}}$$

$$\therefore R_{pu} \geq 2.2 [k\Omega]$$

With the value of Rpu to satisfy the above equation, V_{OLE} becomes 0.4V or below, and with $V_{ILM} (= 0.8V)$, the equation $\textcircled{4}$ is also satisfied.

- V_{OLE} : EEPROM V_{OL} specifications
- I_{OLE} : EEPROM I_{OL} specifications
- V_{ILM} : Microcontroller V_{IL} specifications

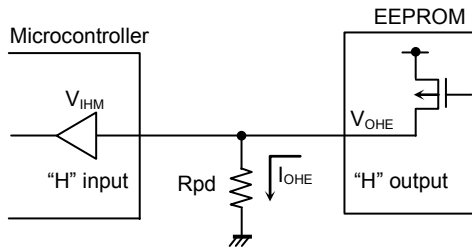

Figure 43. DO Pull down Resistance

$$R_{pd} \geq \frac{V_{OHE}}{I_{OHE}} \quad \dots \textcircled{5}$$

$$V_{OHE} \geq V_{IHM} \quad \dots \textcircled{6}$$

Example) When $V_{CC} = 5V$, $V_{OHE} = 4.8V$, $I_{OHE} = 0.1mA$, $V_{IHM} = 3.5V$ from the equation $\textcircled{5}$

$$R_{pd} \geq \frac{5 - 0.2}{0.1 \times 10^{-3}}$$

$$\therefore R_{pd} \geq 48 [k\Omega]$$

With the value of Rpd to satisfy the above equation, V_{OHE} becomes 4.8V or below, and with $V_{IHM} (= 3.5V)$, the equation $\textcircled{6}$ is also satisfied.

- V_{OHE} : EEPROM V_{OH} specifications
- I_{OHE} : EEPROM I_{OH} specifications
- V_{IHM} : Microcontroller V_{IH} specifications

(b) READY / \overline{BUSY} Status Display (DO terminal)

This display outputs the internal status signal. When CS is started after t_{CS} (Min.200ns) from CS fall after write command input, "H" or "L" output.

R/\overline{B} display = "L" (\overline{BUSY}) = write under execution

(DO status) After the timer circuit in the IC works and creates the period of t_{EW} , this time circuit completes automatically. And write to the memory cell is made in the period of t_{EW} , and during this period, other command is not accepted.

R/\overline{B} display = "H" (READY) = command wait status

(DO status) Even after t_{EW} (Max.4ms) from write of the memory cell, the following command is accepted. Therefore, CS="H" in the period of t_{EW} , and when input is in SK, DI, malfunction may occur, Therefore, set DI="L" in the area CS="H". (Especially, in the case of shared input port, attention is required.)

*Do not input any command while status signal is output. Command input in \overline{BUSY} area is canceled, but command input in READY area is accepted. Therefore, status READY output is canceled, and malfunction and mistake write may be made.

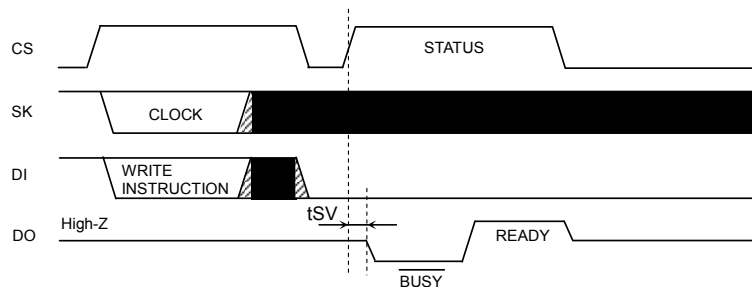

Figure 44. R/\overline{B} Status Output Timing Chart

4. When to directly connect DI and DO

This IC has independent input terminal DI and output terminal DO, wherein signals are handled separately on timing chart. But,, by inserting a resistance R between these DI and DO terminals, it is possible to carry out control by only 1 control line.

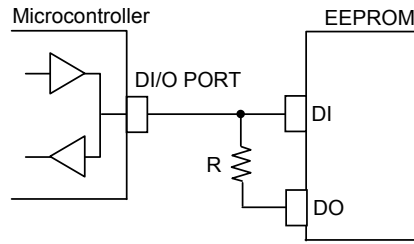

Figure 45. DI, DO Control Line Common Connection

○Data collision of microcontroller DI/O output and DO output and feedback of DO output to DI input.

Drive from the microcontroller DI/O output to DI input on I/O timing, and signal output from DO output occur at the same time in the following points.

(1) 1 clock cycle to take in A0 address data at read command

Dummy bit "0" is output to DO terminal.

→When address data A0 = "1" input, through current route occurs.

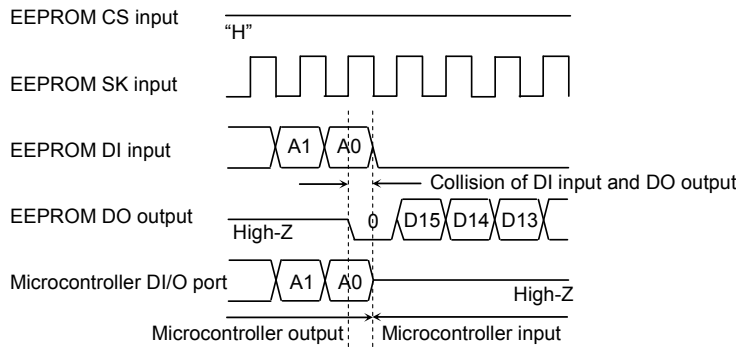

Figure 46. Collision timing at read data output at DI, DO direct connection

(2) Timing of CS = "H" after write command. DO terminal in READY / $\overline{\text{BUSY}}$ function output.

When the next start bit input is recognized, "HIGH-Z" gets in.

→Especially, at command input after write, when CS input is started with microcontroller DI/O output "L", READY output "H" is output from DO terminal, and through current route occurs.

Feedback input at timing of these 4-1) and 4-2) does not cause disorder in basic operations, if resistance R is inserted.

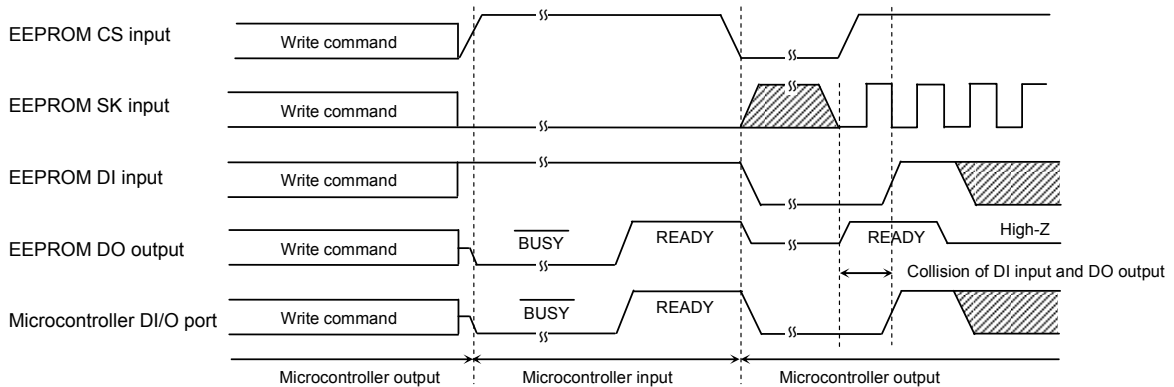

Figure 47. Collision timing at DI, DO direct connection

(a) Selection of Resistance Value R

The resistance R becomes through current limit resistance at data collision. When through current flows, noises of power source line and instantaneous stop of power source may occur. When allowable through current is defined as I, the following relation should be satisfied. Determine allowable current amount in consideration of impedance and so forth of power source line in set. And insert resistance R, and set the value R to satisfy EEPROM input level V_{IH}/V_{IL} , even under influence of voltage decline owing to leak current and so forth. Insertion of R will not cause any influence upon basic operations.

(3) Address data A0 = "1" input, dummy bit "0" output timing

(When microcontroller DI/O output is "H", EEPROM DO outputs "L", and "H" is input to DI)

- Make the through current to EEPROM 10mA or below.
- See to it that the input level V_{IH} of EEPROM should satisfy the following.

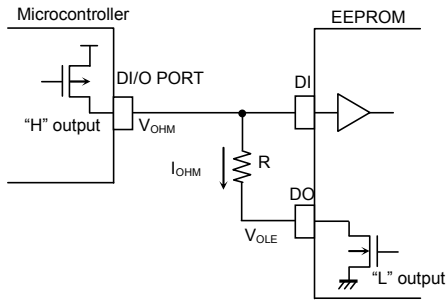

Condition

$$V_{OHM} \leq V_{IHE}$$

$$V_{OHM} \leq I_{OHM} \times R + V_{OLE}$$

At this moment, if $V_{OLE}=0V$,

$$V_{OHM} \leq I_{OHM} \times R$$

$$\therefore R \geq \frac{V_{OHM}}{I_{OHM}} \quad \dots \textcircled{7}$$

- V_{IHE} : EEPROM V_{IH} specifications
- V_{OLE} : EEPROM V_{OL} specifications
- V_{OHM} : Microcontroller V_{OH} specifications
- I_{OHM} : Microcontroller I_{OH} specifications

Figure 48. Circuit at DI, DO direct connection (Microcontroller DI/O "H" output, EEPROM "L" output)

(4) DO status READY output timing

(When the microcontroller DI/O is "L", EEPROM DO outputs "H", and "L" is input to DI)

- Set the EEPROM input level V_{IL} so as to satisfy the following.

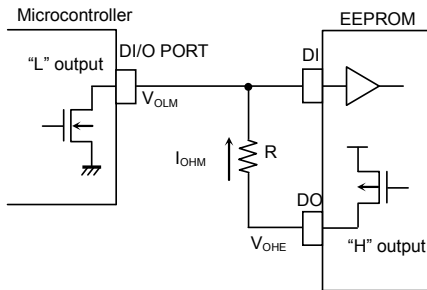

Condition

$$V_{OLM} \geq V_{ILE}$$

$$V_{OLM} \geq V_{OHE} - I_{OLM} \times R$$

As this moment, if $V_{OHE}=V_{CC}$,

$$V_{OLM} \geq V_{CC} - I_{OLM} \times R$$

$$\therefore R \geq \frac{V_{CC} - V_{OLM}}{I_{OLM}} \quad \dots \textcircled{8}$$

- V_{ILE} : EEPROM V_{IL} specifications
- V_{OHE} : EEPROM V_{OH} specifications
- V_{OLM} : Microcontroller V_{OL} specifications
- I_{OLM} : Microcontroller I_{OL} specifications

Example) When $V_{CC}=5V$, $V_{OHM}=5V$, $I_{OHM}=0.4mA$, $V_{OLM}=0.4V$, $I_{OLM}=2.1mA$,

From the equation $\textcircled{7}$,

$$R \geq \frac{V_{OHM}}{I_{OHM}}$$

$$R \geq \frac{5}{0.4 \times 10^{-3}}$$

$$\therefore R \geq 12.5 [k\Omega] \quad \dots \textcircled{9}$$

From the equation $\textcircled{8}$,

$$R \geq \frac{V_{CC} - V_{OLM}}{I_{OLM}}$$

$$R \geq \frac{5 - 0.4}{2.1 \times 10^{-3}}$$

$$\therefore R \geq 2.2 [k\Omega] \quad \dots \textcircled{10}$$

Therefore, from the equations $\textcircled{9}$ and $\textcircled{10}$,

$$\therefore R \geq 12.5 [k\Omega]$$

Figure 49. Circuit at DI, DO direct connection (Microcontroller DI/O "L" output, EEPROM "H" output)

5. Power-Up/Down Conditions

- At power ON/OFF, set CS "L".

When CS is "H", this IC gets in input accept status (active). At power ON, set CS "L" to prevent malfunction from noise. (When CS is in "L" status, all inputs are canceled.) At power decline low power status may prevail. Therefore, at power OFF, set CS "L" to prevent malfunction from noise.

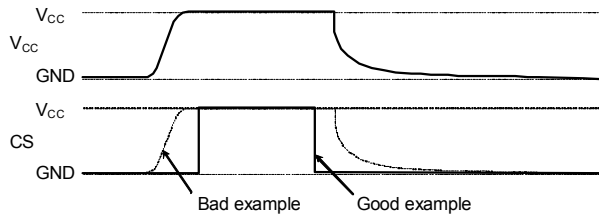

Figure 50. Timing at Power ON/OFF

(Bad example) CS pin is pulled up to Vcc.

In this case, CS becomes "H" (active status), EEPROM may malfunction or have write error due to noises. This is true even when CS input is High-Z.

(Good example) It is "L" at power ON/OFF.

Set 10ms or higher to recharge at power OFF. When power is turned on without observing this condition, IC internal circuit may not be reset.

(1) POR Circuit

This IC has a POR (Power On Reset) circuit as a mistake write countermeasure. After POR action, it gets in write disable status. The POR circuit is valid only when power is ON, and does not work when power is OFF. However, if CS is "H" at power ON/OFF, it may become write enable status owing to noises and the likes. For secure actions, observe the following conditions.

- Set CS="L"
- Turn on power so as to satisfy the recommended conditions of t_R , t_{OFF} , V_{bot} for POR circuit action.

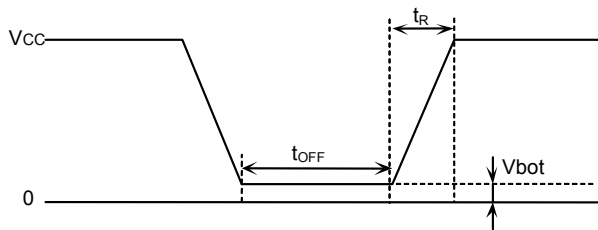

Recommended conditions of t_R , t_{OFF} , V_{bot}

t_R	t_{OFF}	V_{bot}
10ms or below	10ms or higher	0.3V or below
100ms or below	10ms or higher	0.2V or below

Figure 51. Rise Waveform Diagram

(2) V_{CC} Circuit

V_{CC} (V_{CC} -Lockout) circuit prevents data rewrite action at low power, and prevents wrong write. At V_{CC} voltage (Typ=1.9V) or below, it prevents data rewrite.

6. Noise Countermeasures

(1) V_{CC} noise (bypass capacitor)

When noise or surge gets in the power source line, malfunction may occur. Therefore, in removing these, it is recommended to attach a bypass capacitor ($0.1 \mu F$) between IC V_{CC} and GND as close to IC as possible. It is also recommended to attach a bypass capacitor between board V_{CC} and GND.

(2) SK noise

When the rise time (t_R) of SK is long, and a certain degree or more of noise exists, malfunction may occur owing to clock bit displacement.

To avoid this, a Schmitt trigger circuit is built in SK input. The hysteresis width of this circuit is set about 0.2V. If noise exists at SK input, set the noise amplitude 0.2Vp-p or below. And it is recommended to set the rise time (t_R) of SK to 100ns or below. In the case when the rise time is 100ns or higher, take sufficient noise countermeasures. Make the clock rise, fall time as small as possible.

Operational Notes

1. Described numeric values and data are design representative values, and the values are not guaranteed.

2. Application Circuit

Although we can recommend the application circuits contained herein with a relatively high degree of confidence, we ask that you verify all characteristics and specifications of the circuit as well as its performance under actual conditions. Please note that we cannot be held responsible for problems that may arise due to patent infringements or noncompliance with any and all applicable laws and regulations.

3. Absolute Maximum Ratings

Operating the IC over the absolute maximum ratings may damage the IC. The damage can either be a short circuit between pins or an open circuit between pins. Therefore, it is important to consider circuit protection measures, such as adding a fuse, in case the IC is operated over the absolute maximum ratings.

4. Ground Voltage

The voltage of the ground pin must be the lowest voltage of all pins of the IC at all operating conditions. Ensure that no pins are at a voltage below the ground pin at any time, even during transient condition.

5. Thermal Consideration

Use a thermal design that allows for a sufficient margin by taking into account the permissible power dissipation (Pd) in actual operating conditions. Consider Pc that does not exceed Pd in actual operating conditions ($P_c \geq P_d$).

$$\text{Package Power dissipation} \quad : P_d \text{ (W)} = (T_{jmax} - T_a) / \theta_{ja}$$

$$\text{Power Dissipation} \quad : P_c \text{ (W)} = (V_{CC} - V_o) \times I_o + V_{cc} \times I_b$$

$$\left(\begin{array}{l} T_{jmax} : \text{Maximum junction temperature} = 150^\circ\text{C}, T_a : \text{Peripheral temperature} [^\circ\text{C}], \\ \theta_{ja} : \text{Thermal resistance of package-ambience} [^\circ\text{C/W}], P_d : \text{Package Power dissipation [W]}, \\ P_c : \text{Power dissipation [W]}, V_{CC} : \text{Input Voltage}, V_o : \text{Output Voltage}, I_o : \text{Load}, I_b : \text{Bias Current} \end{array} \right)$$

6. Short between pins and mounting errors

Be careful when mounting the IC on printed circuit boards. The IC may be damaged if it is mounted in a wrong orientation or if pins are shorted together. Short circuit may be caused by conductive particles caught between the pins.

7. Operation under strong electromagnetic field

Operating the IC in the presence of a strong electromagnetic field may cause the IC to malfunction.

Part Numbering

B R 9 3 H 6 6 x x x x - 2 C	x x
-----------------------------	-----

Bus Type
93: Microwire Bus

Operating Temperature
H: -40°C to +125°C

Capacity
66 = 4Kbit

Package
RFVM : MSOP8
RFVT : TSSOP-B8
RF : SOP8
RFJ : SOP-J8

Process Code

Package Specifications
TR : reel shape emboss taping (MSOP8)
E2 : reel shape emboss taping (TSSOP-B8, SOP8, SOP-J8)

Lineup

Capacity	Package		Orderable Part Number
	Type	Quantity	
4K	MSOP8	Reel of 3000	BR93H66RFVM-2CTR
	TSSOP-B8		BR93H66RFVT-2CE2
	SOP8	Reel of 2500	BR93H66RF-2CE2
	SOP-J8		BR93H66RFJ-2CE2

Physical Dimentions, Tape and Reel Infomation

MSOP8

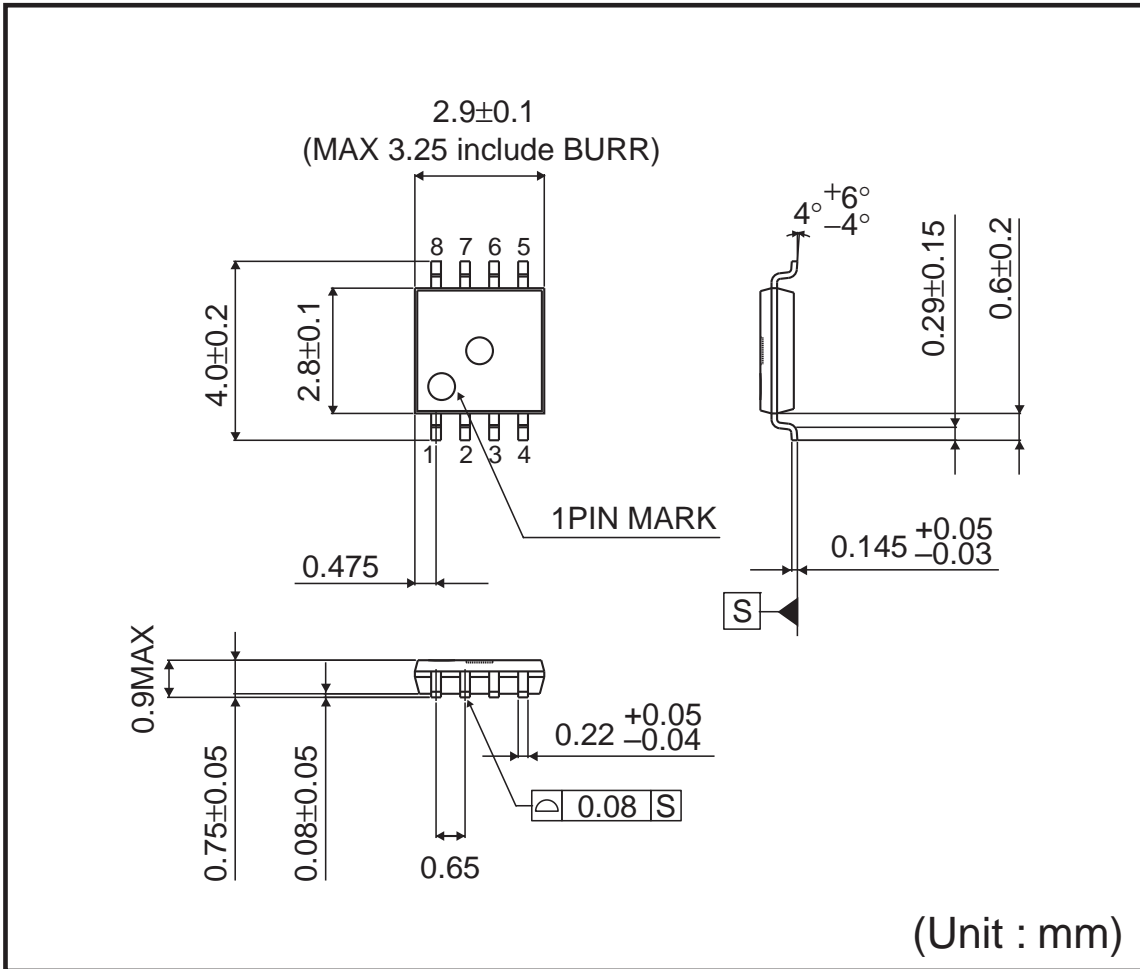

<Tape and Reel information>

Tape	Embossed carrier tape
Quantity	3000pcs
Direction of feed	TR (The direction is the 1pin of product is at the upper right when you hold reel on the left hand and you pull out the tape on the right hand)

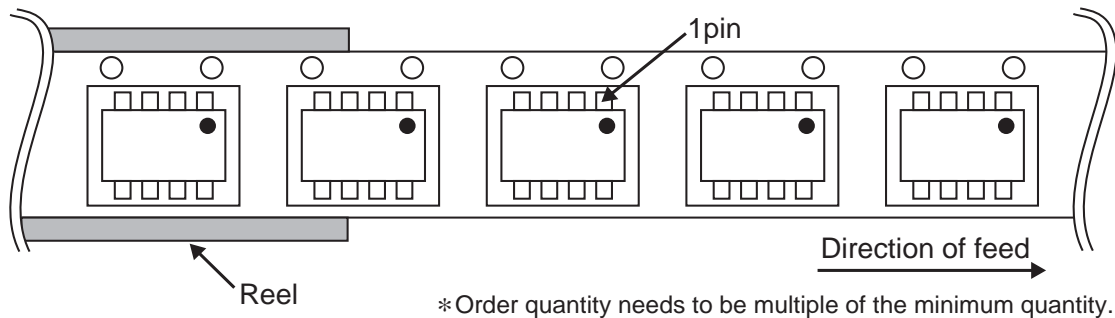

TSSOP-B8

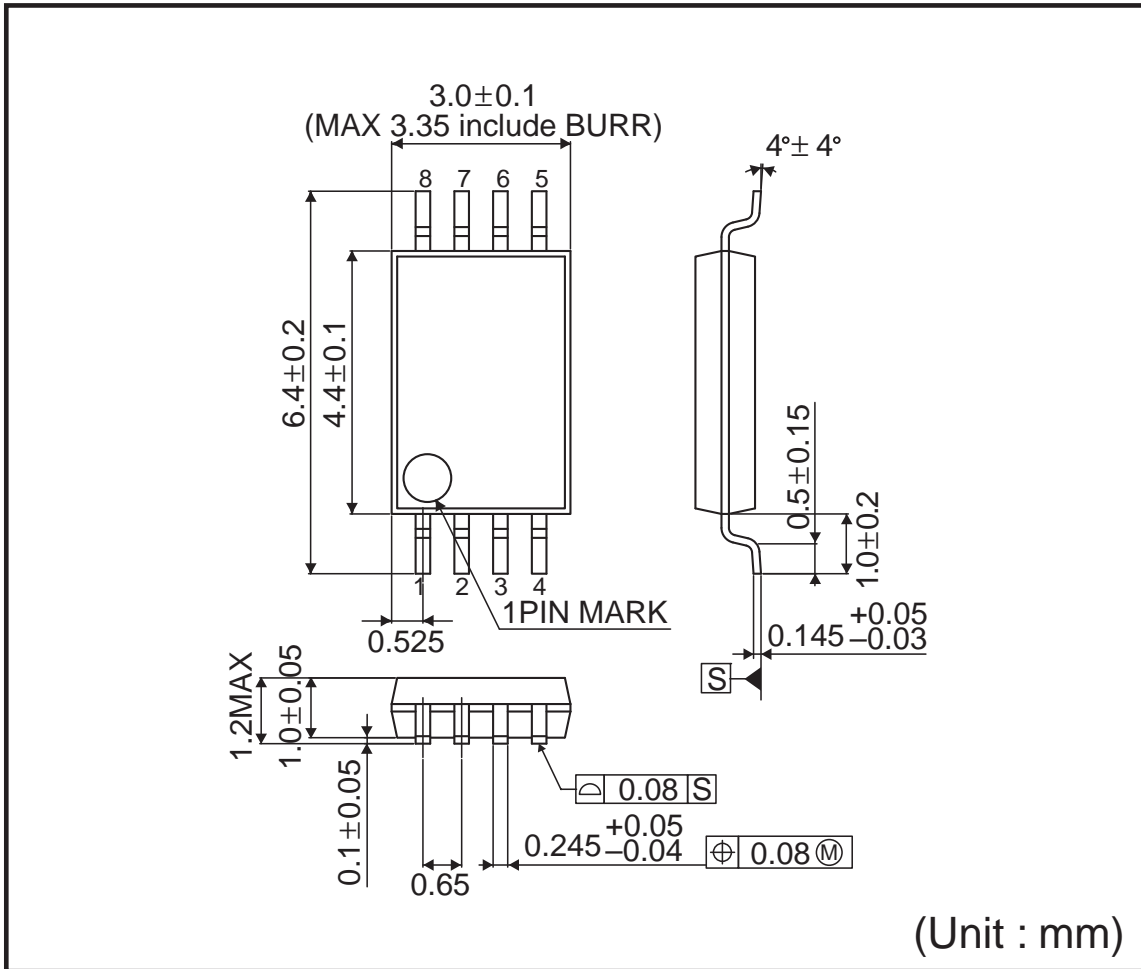

<Tape and Reel information>

Tape	Embossed carrier tape
Quantity	3000pcs
Direction of feed	E2 (The direction is the 1pin of product is at the upper left when you hold reel on the left hand and you pull out the tape on the right hand)

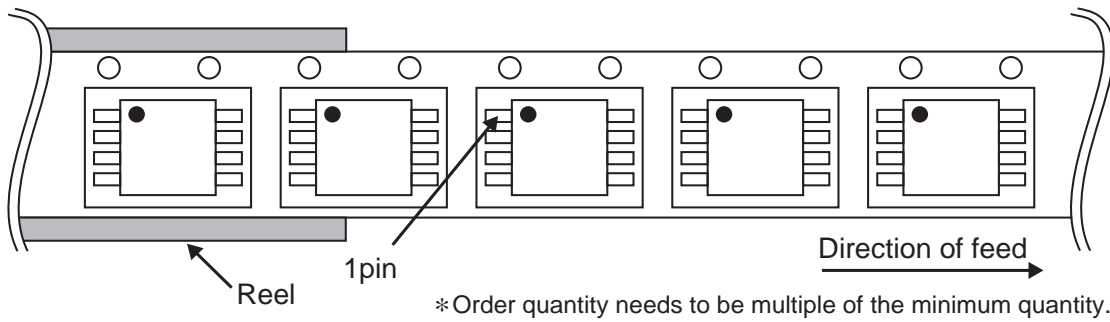

SOP8

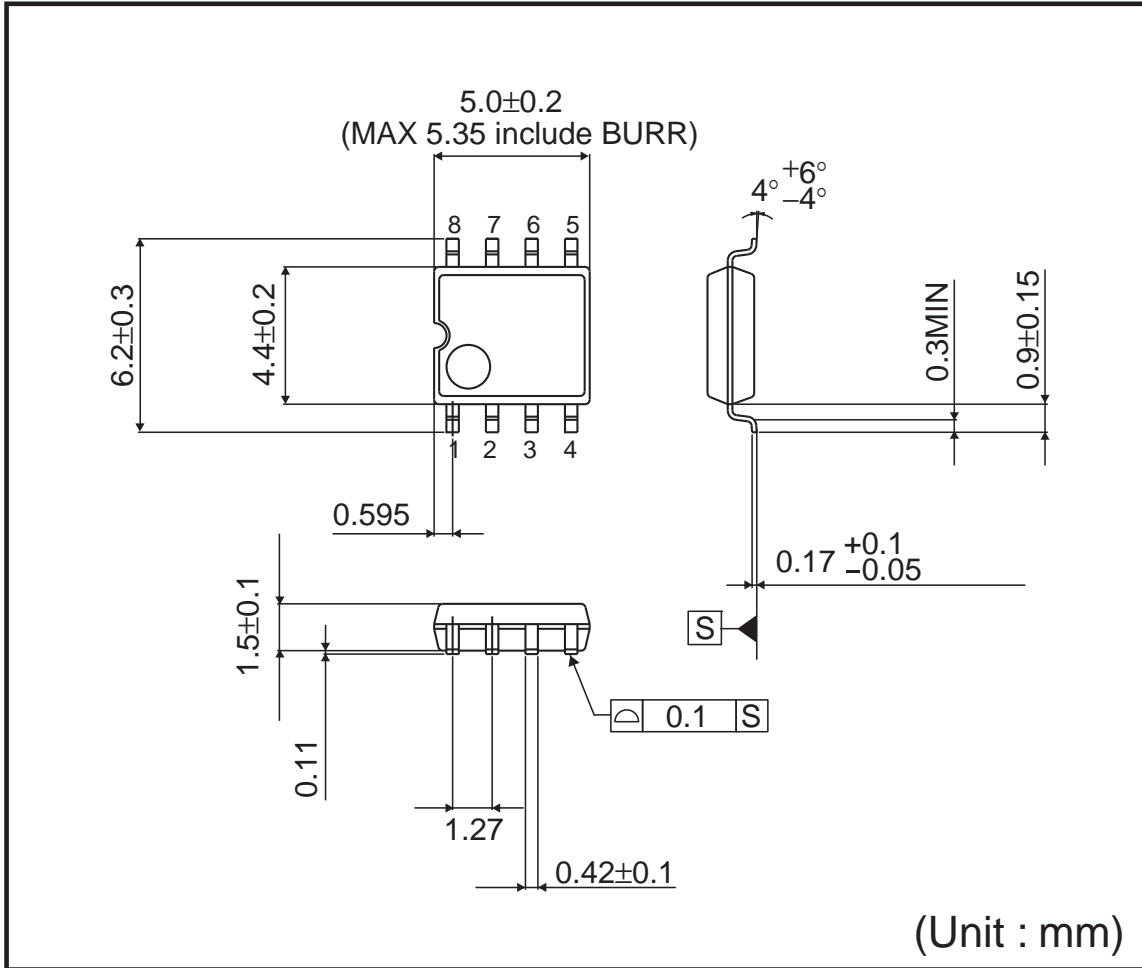

<Tape and Reel information>

Tape	Embossed carrier tape
Quantity	2500pcs
Direction of feed	E2 (The direction is the 1pin of product is at the upper left when you hold reel on the left hand and you pull out the tape on the right hand)

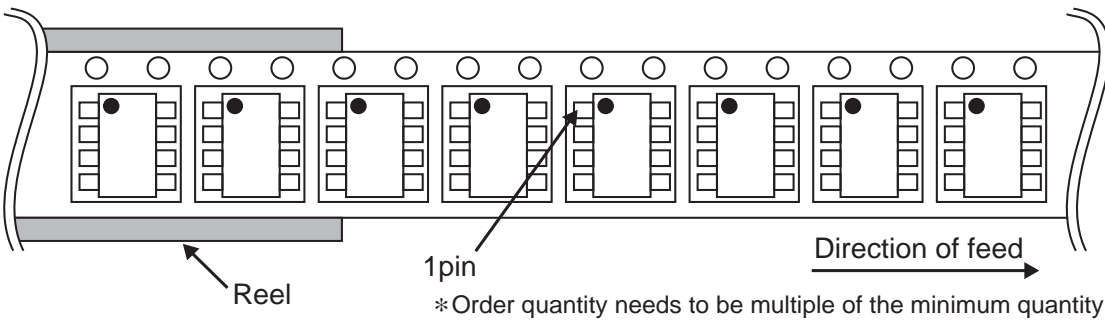

SOP-J8

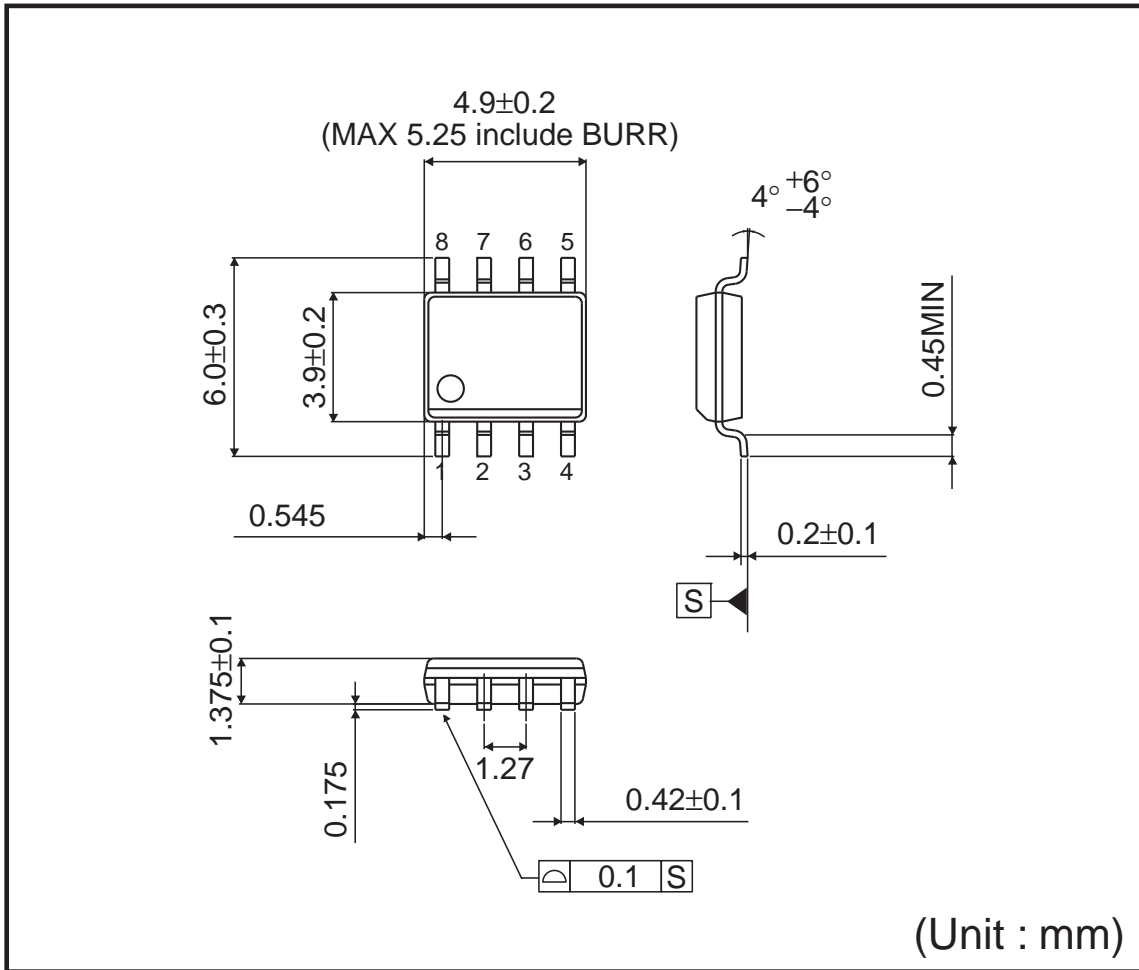

<Tape and Reel information>

Tape	Embossed carrier tape
Quantity	2500pcs
Direction of feed	E2 (The direction is the 1pin of product is at the upper left when you hold reel on the left hand and you pull out the tape on the right hand)

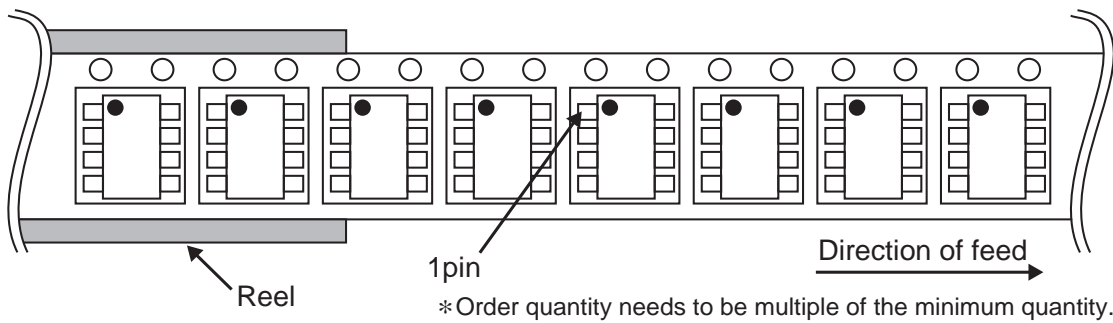

Marking Diagrams

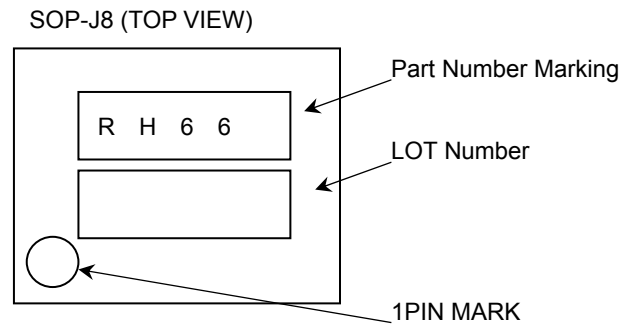
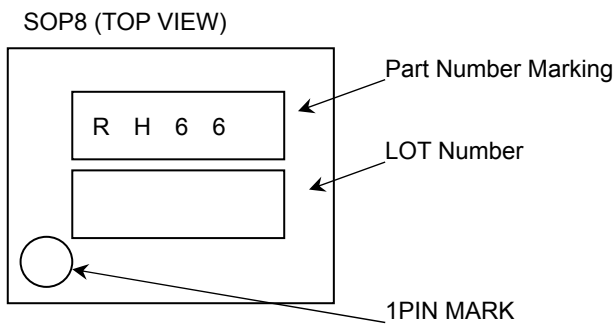
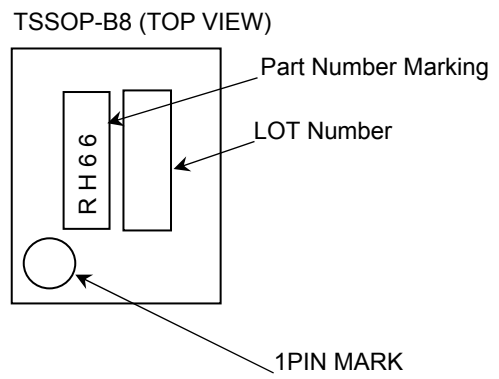
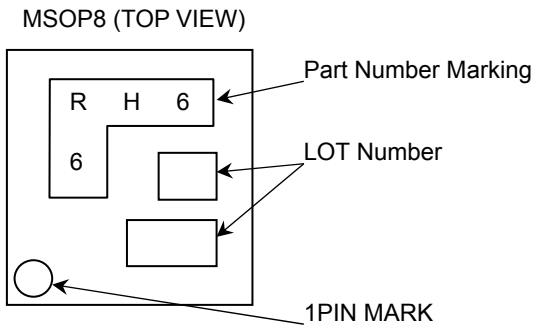

Capacity	Product Name Marking	Package Type
4K	RH66	MSOP8
		TSSOP-B8
		SOP8
		SOP-J8

Revision History

Date	Revision	Changes
31.Aug.2012	001	New Release
19.Dec.2012	002	All page P2 Document converted to new format. Data Retention was changed.
01.Dec.2015	003	P1 Data Retention and Write Cycles were modified. P6 Graph of Figure 4. was modified. P13 Reference Page Number was modified. P13 Bit B2 and B1 were removed. P14 Comments in WRAL were modified and added. P14 Figure 31. and Figure 32. were modified. P18 Text Bugs were modified in Figure 42.and Figure 44..

Notice

Precaution on using ROHM Products

1. If you intend to use our Products in devices requiring extremely high reliability (such as medical equipment ^(Note 1), aircraft/spacecraft, nuclear power controllers, etc.) and whose malfunction or failure may cause loss of human life, bodily injury or serious damage to property ("Specific Applications"), please consult with the ROHM sales representative in advance. Unless otherwise agreed in writing by ROHM in advance, ROHM shall not be in any way responsible or liable for any damages, expenses or losses incurred by you or third parties arising from the use of any ROHM's Products for Specific Applications.

(Note1) Medical Equipment Classification of the Specific Applications

JAPAN	USA	EU	CHINA
CLASS III	CLASS III	CLASS II b	CLASS III
CLASS IV		CLASS III	

2. ROHM designs and manufactures its Products subject to strict quality control system. However, semiconductor products can fail or malfunction at a certain rate. Please be sure to implement, at your own responsibilities, adequate safety measures including but not limited to fail-safe design against the physical injury, damage to any property, which a failure or malfunction of our Products may cause. The following are examples of safety measures:
 - [a] Installation of protection circuits or other protective devices to improve system safety
 - [b] Installation of redundant circuits to reduce the impact of single or multiple circuit failure
3. Our Products are not designed under any special or extraordinary environments or conditions, as exemplified below. Accordingly, ROHM shall not be in any way responsible or liable for any damages, expenses or losses arising from the use of any ROHM's Products under any special or extraordinary environments or conditions. If you intend to use our Products under any special or extraordinary environments or conditions (as exemplified below), your independent verification and confirmation of product performance, reliability, etc. prior to use, must be necessary:
 - [a] Use of our Products in any types of liquid, including water, oils, chemicals, and organic solvents
 - [b] Use of our Products outdoors or in places where the Products are exposed to direct sunlight or dust
 - [c] Use of our Products in places where the Products are exposed to sea wind or corrosive gases, including Cl₂, H₂S, NH₃, SO₂, and NO₂
 - [d] Use of our Products in places where the Products are exposed to static electricity or electromagnetic waves
 - [e] Use of our Products in proximity to heat-producing components, plastic cords, or other flammable items
 - [f] Sealing or coating our Products with resin or other coating materials
 - [g] Use of our Products without cleaning residue of flux (even if you use no-clean type fluxes, cleaning residue of flux is recommended); or Washing our Products by using water or water-soluble cleaning agents for cleaning residue after soldering
 - [h] Use of the Products in places subject to dew condensation
4. The Products are not subject to radiation-proof design.
5. Please verify and confirm characteristics of the final or mounted products in using the Products.
6. In particular, if a transient load (a large amount of load applied in a short period of time, such as pulse. is applied, confirmation of performance characteristics after on-board mounting is strongly recommended. Avoid applying power exceeding normal rated power; exceeding the power rating under steady-state loading condition may negatively affect product performance and reliability.
7. De-rate Power Dissipation depending on ambient temperature. When used in sealed area, confirm that it is the use in the range that does not exceed the maximum junction temperature.
8. Confirm that operation temperature is within the specified range described in the product specification.
9. ROHM shall not be in any way responsible or liable for failure induced under deviant condition from what is defined in this document.

Precaution for Mounting / Circuit board design

1. When a highly active halogenous (chlorine, bromine, etc.) flux is used, the residue of flux may negatively affect product performance and reliability.
2. In principle, the reflow soldering method must be used on a surface-mount products, the flow soldering method must be used on a through hole mount products. If the flow soldering method is preferred on a surface-mount products, please consult with the ROHM representative in advance.

For details, please refer to ROHM Mounting specification

Precautions Regarding Application Examples and External Circuits

1. If change is made to the constant of an external circuit, please allow a sufficient margin considering variations of the characteristics of the Products and external components, including transient characteristics, as well as static characteristics.
2. You agree that application notes, reference designs, and associated data and information contained in this document are presented only as guidance for Products use. Therefore, in case you use such information, you are solely responsible for it and you must exercise your own independent verification and judgment in the use of such information contained in this document. ROHM shall not be in any way responsible or liable for any damages, expenses or losses incurred by you or third parties arising from the use of such information.

Precaution for Electrostatic

This Product is electrostatic sensitive product, which may be damaged due to electrostatic discharge. Please take proper caution in your manufacturing process and storage so that voltage exceeding the Products maximum rating will not be applied to Products. Please take special care under dry condition (e.g. Grounding of human body / equipment / solder iron, isolation from charged objects, setting of Ionizer, friction prevention and temperature / humidity control).

Precaution for Storage / Transportation

1. Product performance and soldered connections may deteriorate if the Products are stored in the places where:
 - [a] the Products are exposed to sea winds or corrosive gases, including Cl₂, H₂S, NH₃, SO₂, and NO₂
 - [b] the temperature or humidity exceeds those recommended by ROHM
 - [c] the Products are exposed to direct sunshine or condensation
 - [d] the Products are exposed to high Electrostatic
2. Even under ROHM recommended storage condition, solderability of products out of recommended storage time period may be degraded. It is strongly recommended to confirm solderability before using Products of which storage time is exceeding the recommended storage time period.
3. Store / transport cartons in the correct direction, which is indicated on a carton with a symbol. Otherwise bent leads may occur due to excessive stress applied when dropping of a carton.
4. Use Products within the specified time after opening a humidity barrier bag. Baking is required before using Products of which storage time is exceeding the recommended storage time period.

Precaution for Product Label

QR code printed on ROHM Products label is for ROHM's internal use only.

Precaution for Disposition

When disposing Products please dispose them properly using an authorized industry waste company.

Precaution for Foreign Exchange and Foreign Trade act

Since concerned goods might be fallen under listed items of export control prescribed by Foreign exchange and Foreign trade act, please consult with ROHM in case of export.

Precaution Regarding Intellectual Property Rights

1. All information and data including but not limited to application example contained in this document is for reference only. ROHM does not warrant that foregoing information or data will not infringe any intellectual property rights or any other rights of any third party regarding such information or data.
2. ROHM shall not have any obligations where the claims, actions or demands arising from the combination of the Products with other articles such as components, circuits, systems or external equipment (including software).
3. No license, expressly or implied, is granted hereby under any intellectual property rights or other rights of ROHM or any third parties with respect to the Products or the information contained in this document. Provided, however, that ROHM will not assert its intellectual property rights or other rights against you or your customers to the extent necessary to manufacture or sell products containing the Products, subject to the terms and conditions herein.

Other Precaution

1. This document may not be reprinted or reproduced, in whole or in part, without prior written consent of ROHM.
2. The Products may not be disassembled, converted, modified, reproduced or otherwise changed without prior written consent of ROHM.
3. In no event shall you use in any way whatsoever the Products and the related technical information contained in the Products or this document for any military purposes, including but not limited to, the development of mass-destruction weapons.
4. The proper names of companies or products described in this document are trademarks or registered trademarks of ROHM, its affiliated companies or third parties.

General Precaution

1. Before you use our Products, you are requested to carefully read this document and fully understand its contents. ROHM shall not be in any way responsible or liable for failure, malfunction or accident arising from the use of any ROHM's Products against warning, caution or note contained in this document.
2. All information contained in this document is current as of the issuing date and subject to change without any prior notice. Before purchasing or using ROHM's Products, please confirm the latest information with a ROHM sales representative.
3. The information contained in this document is provided on an "as is" basis and ROHM does not warrant that all information contained in this document is accurate and/or error-free. ROHM shall not be in any way responsible or liable for any damages, expenses or losses incurred by you or third parties resulting from inaccuracy or errors of or concerning such information.